



CLARKS
EXCEED YOUR LIMITATIONS



TECHNICAL PRODUCT CATALOGUE
2023/24

clarks.bike

CLARKS



CLARKS

Clarks are one of the fastest growing brands supplying cycle products into the OEM and Aftermarket sales channels.

Clarks are an ever expanding company supplying OEM and aftermarket products and a full aftermarket catalogue to more than 80 countries.

Clarks offer complete marketing and point of sale support across all products to distributors.

Clarks have manufacturing and distribution in China, Taiwan and around the world.

Clarks design, manufacture and test products to the highest standard - always testing beyond industry standards of ISO 4210.

Clarks have comprehensive product testing and development programmes with world-class riders testing all products to their very limits.



CLARKS



Clarks was founded in 1943 manufacturing Motorcycle and Cycle cables. By the 1970's Clarks was offering both Automotive and agricultural products to the market. In the 1990's Clarks was a part of one of the largest automotive groups in the world, turning over more than \$4 billion USD bringing innovative and well-designed products to the market.

It was in the 1990's that Clarks offered the first hydraulic disc brake to the market - both aftermarket and OEM. Today Clark's support more than 300 brands with OEM products and supply over 80 countries with a service and aftermarket programme.

Clarks offers full support to all its customers, always offering great value for money products.

Today Clarks is well known throughout the world as a great value for money brand, always offering great design functionality, with our engineering background we are able to ensure excellent performance from our products.

We are dedicated to our customers and endeavour to support them in every way possible. So in response to an ever changing retail landscape we have built up and developed our customer support framework to help your business be more efficient.

Clarks Service Centre

Our service centre provides all our customers with a comprehensive 'back-up' service. We freely provide warranty work, and technical advice as well as a replacement parts catalogue for all our current and older hydraulic and mechanical disc brake systems. To further assist we have a range of instructional 'How To Videos' on our website demonstrating how parts can be fitted and replaced when the need arises.

Clarks UK distribution centre

Our UK distribution centre provides customers with the peace facility to order what they need, when they need it. With a range of over 150 of our most popular products and no minimum order restrictions we can guarantee reliable product support to our UK customers.

Clarks Worldwide distribution centres

Our worldwide distribution centres guarantee effective and reliable delivery of products across Central and Western Europe as well as Eastern Europe, U.S.A, South America and India.

Clarks 24 hour dispatch

Our comprehensive distribution network means that we can deliver product where ever possible within 24 hours of order placement.

Clarks Distributor Portal

We offer all our distributor customers the opportunity to take advantage of the Clarks Distributor Portal. Accessible through our website at www.clarks.bike. A simple and easy to use site, it provides customers access to our product range 24 hours a day. As well as showing live stock information, it shows our latest product promotions and offers keeping all our customers up dated as efficiently as possible.

CONTACT

Hotline: +44 (0)1455 254800

Email: info@clarks.bike

SERVICE SUPPORT, PRODUCT & VIDEO

Visit: www.clarks.bike/how-to-videos.html

24 HOUR DISPATCH

All replacement parts ordered from www.clarks.bike are dispatched within 24 hours.

CONTENTS

Page 4	Hydraulic disc brakes
Page 18	Mechanical disc brakes
Page 24	Disc pads
Page 30	Rotors
Page 34	Calliper brackets
Page 42	V-Brakes
Page 44	Brake pads & cartridges
Page 50	Cable kits & wires
Page 59	Cassettes
Page 60	Chains & accessories
Page 62	Chainrings
Page 64	Bottom brackets
Page 65	Gears
Page 66	Grips
Page 76	E-Bike
Page 78	Headsets
Page 80	Hydraulics
Page 88	Service - trays
Page 90	Service - Wire, cable & hose
Page 92	Service - Parts
Page 95	Bottle Cages



HYDRAULIC DISC BRAKES

Hydraulic Disc brakes offer cyclists the most powerful and consistent method of stopping in wet and dry conditions alike. The Clarks range of lightweight hydraulic brake systems feature controlled braking performance with power and modulation. Complimented with 2, 3 or 4 finger levers, lever reach adjustment and self adjusting pistons, our brake sets provide the rider with full control at all times. We have a brake set that suits all style of riders, from the city commuter to the most adventurous downhill rider. All our hydraulic brake systems use mineral oil that doesn't damage the environment and are available with various rotor sizes from 140mm to 203mm.

-  EASY FIT
-  LIGHTWEIGHT
-  POST MOUNT
-  INTERNATIONAL STANDARD

 **SERVICE & REPAIR PARTS**
clarks.bike/order-spare-parts.html

 **SERVICE & FITTING VIDEOS**
clarks.bike/how-to-videos.html

 **PRODUCT HELPLINE**
info@clarks.bike
+44 (0)1455 254800

Hydraulic disc brakes
4-17

Mechanical disc brakes
18-23

Disc pads
24-29

Rotors
30-35

Calliper brackets
36-39

V-Brakes
40-43

Brake pads & cartridges
44-49

Cable kits & wires
50-57

Cassettes
59

Chains & accessories
60-61

Chainrings
62-63

Bottom brackets
64

Gears
65

Grips
66-75

E-Bike
76-77

Headsets
78-79

Hydraulics
80-87

Service - trays
88-89

Service - Wire, cable & hose
90-91

Service - Parts
92-94

Bottle Cages
95

M4 CALLIPER ASSEMBLY

1. 4 x 16mm Piston Calliper
2. Self adjusting pistons
3. 2 Piece calliper design

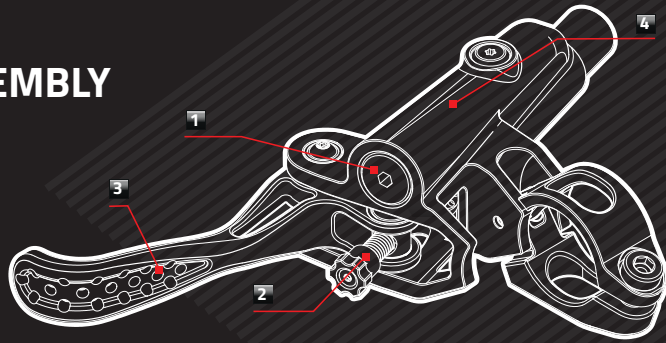
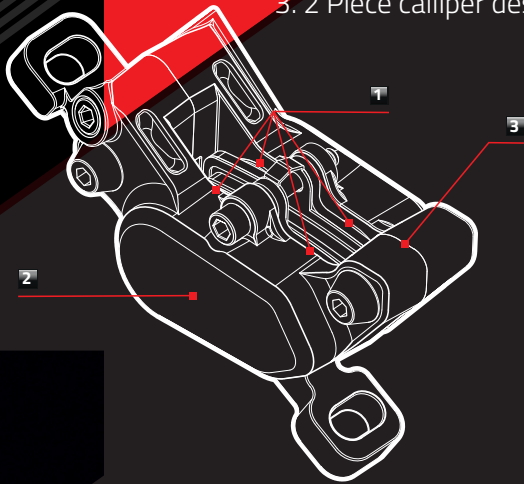

M4 LEVER ASSEMBLY

1. High quality finish
2. Reach adjustment
3. Ergonomic finger tip lever
4. Mineral Oil

CLARKS

DISC BRAKES ■ HYDRAULIC

All Clarks hydraulic disc brakes are approved to ISO4210

CLOUT 1

The CLOUT 1 hydraulic brake system has the capability of a much higher end brake in the market, providing the rider with greater power, consistency and feel, all at a price that is designed to compete with entry level bikes. CLOUT1 has been built on the foundations of our hugely successful M Series brake range, maintaining superb quality and reliability even at this lower price point. The CLOUT1 operates on mineral oil (protects the environment), features a 2 piston calliper and an ergonomic designed lever assembly with reach adjustment.

- Lightweight brake system for MTB, and off-road riding
- 2 Piston hydraulic brake
- Lever reach adjustment to suit all hand sizes
- International standard and Post mount fit
- Mineral oil fluid to protect the environment
- Stainless steel rotors
- Spare olives to allow for hose reduction
- Weight - 304g

Complies with and exceeds ISO4210 regulations

Box Contents:

Front and rear sets - 2 x Callipers, 2 x levers, 2 x rotors & bolts, pads & hoses.
Front - 1x Calliper, 1 x lever, 1 x rotor and bolts, pads & hose.
Rear - 1x Calliper, 1 x lever, 1 x rotor and bolts, pads & hose.

Replacement Part Numbers:

Rotor - TL-027 - [See page 35](#)
 Pads - VX811, VRX811, VRS811 - [See page 27](#)
 Service parts - [See page 86/87](#)

Options available:

Part Numbers:	Description:
HY-19-1F160AMROW	Front 160mm
HY-19-1F180AMROW	Front 180mm
HY-19-1F180PMAMROW	Front 180mm Post Mount
HY-19-1F180PMR160AMROW	Front 180mm & Rear 160mm set
HY-19-1FR160AMROW	Front & Rear 160mm set
HY-19-1R160AMROW	Rear 160mm



Hydraulic disc brakes
4-17

Mechanical disc brakes
18-23

Disc pads
24-29

Rotors
30-35

Calliper brackets
36-39

V-Brakes
40-43

Brake pads & cartridges
44-49

Cable kits & wires
50-57

Cassettes
59

Chains & accessories
60-61

Chainrings
62-63

Bottom brackets
64

Gears
65

Grips
66-75

E-Bike
76-77

Headsets
78-79

Hydraulics
80-87

Service - trays
88-89

Service - Wire, cable & hose
90-91

Service - Parts
92-94

Bottle Cages
95

DISC BRAKES ■ HYDRAULIC

All Clarks hydraulic disc brakes are approved to ISO4210

CLOUT PLUS

The Clout Plus, Clarks hydraulic brake system, has all the benefits of the popular Clout brake, but with a larger piston size of 22mm. This results in greater power and control, making the Clout Plus an ideal brake for downhill riders and e-bikes. Built on the success of the M Series brake sets, the Clout Plus features, self adjusting 22mm pistons, Semi-metallic pads, for improved wear and control, lever reach adjustment and mineral oil fluid.

- Lightweight brake system for MTB, downhill and e-bikes
- Self adjusting 22mm calliper pistons for greater stopping force
- 3 Finger lever for greater braking force and control at the lever
- Semi-metallic pads for improved wear and control
- Lever reach adjustment to suit all hand sizes
- International standard and Post mount fit available
- Mineral oil fluid to protect the environment
- Stainless steel rotors
- Spare olives to allow for hose reduction
- Weight - 300g

Complies with and exceeds EN15194 and ISO4210 regulations

Box Contents:

Front and rear sets - 2 x Callipers, 2 x levers, 2 x rotors & bolts, pads & hoses.

Replacement Part Numbers:

Rotor - TL-027 - See page 35

Pads - VX811, VRX811, VRS811 - See page 27

Options available:

Part Numbers:	Description:
HY21PF180R160PM-AM	Front 180mm & Rear 160mm set



- 3 Finger lever
- Self adjusting 22mm calliper pistons
- Semi-Metallic pads

Hydraulic disc brakes
4-17

Mechanical disc brakes
18-23

Disc pads
24-29

Rotors
30-35

Calliper brackets
36-39

V-Brakes
40-43

Brake pads & cartridges
44-49

Cable kits & wires
50-57

Cassettes
59

Chains & accessories
60-61

Chainrings
62-63

Bottom brackets
64

Gears
65

Grips
66-75

E-Bike
76-77

Headsets
78-79

Hydraulics
80-87

Service - trays
88-89

Service - Wire, cable & hose
90-91

Service - Parts
92-94

Bottle Cages
95

DISC BRAKES ■ HYDRAULIC

All Clarks hydraulic disc brakes are approved to ISO4210

CLOUT JUNIOR

The CLOUT Junior hydraulic brake system has all the features of the CLOUT1, but with a short reach lever for riders with smaller hands. Built on the foundations of our hugely successful M Series brake range, maintaining superb quality and reliability even at this lower price point, CLOUT Junior operates on mineral oil (protects the environment), features a 2 piston calliper and short reach ergonomic designed lever assembly with reach adjustment.

- Lightweight brake system for MTB, and off-road riding
- Short reach lever for smaller hands
- 2 Piston hydraulic brake
- Lever reach adjustment to suit all hand sizes
- International standard and Post mount fit
- Mineral oil fluid to protect the environment
- Stainless steel rotors
- Spare olives to allow for hose reduction
- Weight - 304g

Complies with and exceeds ISO4210 regulations

Box Contents:

Front and rear sets - 2 x Callipers, 2 x levers, 2 x rotors & bolts, pads & hoses.

Front - 1x Calliper, 1 x lever, 1 x rotor and bolts, pads & hose.

Rear - 1x Calliper, 1 x lever, 1 x rotor and bolts, pads & hose.

Replacement Part Numbers:

Rotor - TL-027 - [See page 35](#)

Pads - VX811, VRX811, VRS811 - [See page 27](#)

Service parts - [See page 86/87](#)

Options available:

Part Numbers:	Description:
CLOUTJF180PMR160ISR0WAM	Front 180mm & Rear 160mm I.S. set
CLOUTJF180PMR160ISUKAM	Front 180mm & Rear 160mm I.S. set (UK)



- Hydraulic disc brakes 4-17
- Mechanical disc brakes 18-23
- Disc pads 24-29
- Rotors 30-35
- Calliper brackets 36-39
- V-Brakes 40-43
- Brake pads & cartridges 44-49
- Cable kits & wires 50-57
- Cassettes 59
- Chains & accessories 60-61
- Chainrings 62-63
- Bottom brackets 64
- Gears 65
- Grips 66-75
- E-Bike 76-77
- Headsets 78-79
- Hydraulics 80-87
- Service - trays 88-89
- Service - Wire, cable & hose 90-91
- Service - Parts 92-94
- Bottle Cages 95

DISC BRAKES ■ HYDRAULIC

All Clarks hydraulic disc brakes are approved to ISO4210

M2

The **award winning** M2 has been designed specifically for the cycle enthusiast. It brings high level performance and braking power to the MTB and hybrid rider, at an entry level price. The twin piston callipers of the M2 deliver superb braking performance in all weather conditions. Supported by a sleek and compact lever design, this braking system will provide exceptional reliability and consistent performance.

- Lightweight 2 piston hydraulic brake system for MTB and off-road riding
- High quality finish
- Self adjusting pistons
- Lever reach adjustment to suit all hand sizes
- International standard and Post mount fit available
- Mineral oil fluid to protect the environment
- Stainless steel rotors
- Spare olives to allow for hose reduction
- Weight - 274g

Complies with and exceeds EN15194 and ISO4210 regulations

Box Contents:

Front and rear sets - 2 x Callipers, 2 x levers, 2 x rotors & bolts, pads & hoses.

Front - 1x Calliper, 1 x lever, 1 x rotor and bolts, pads & hose.

Rear - 1x Calliper, 1 x lever, 1 x rotor and bolts, pads & hose.

Replacement Part Numbers:

Rotor - TL-027 - [See page 35](#)

Pads (Serial No. L) - VX852, VRX852, VRS852 - [See page 27](#)

Pads (Serial No. F and O) - VX811, VRX811, VRS811 - [See page 27](#)

Service parts - [See page 86/87](#)

Options available:

Part Numbers:	Description:
M2F160BAMROW-O	Front 160mm
M2F180BAMROW-O	Front 180mm
M2R160BAMROW-O	Rear 160mm
M2R180BAMROW-O	Rear 180mm
M2FR160BAMROW-O	Front & Rear 160mm set
M2FR180BAMROW-O	Front & Rear 180mm set
M2180160BAMROW-O	Front 180mm & Rear 160mm set



Hydraulic disc brakes
4-17

Mechanical disc brakes
18-23

Disc pads
24-29

Rotors
30-35

Calliper brackets
36-39

V-Brakes
40-43

Brake pads & cartridges
44-49

Cable kits & wires
50-57

Cassettes
59

Chains & accessories
60-61

Chainrings
62-63

Bottom brackets
64

Gears
65

Grips
66-75

E-Bike
76-77

Headsets
78-79

Hydraulics
80-87

Service - trays
88-89

Service - Wire, cable & hose
90-91

Service - Parts
92-94

Bottle Cages
95

DISC BRAKES ■ HYDRAULIC

All Clarks hydraulic disc brakes are approved to ISO4210

M2 JUNIOR

Offering all the performance advantages of the award winning M2, Clarks M2 Junior brings high level performance and braking power to the junior MTB and hybrid bike rider. A combination of a shorter reach lever, (with reach adjustment), and self adjusting calliper pistons makes the M2 junior the perfect brake set for riders with small hands.

- Lightweight 2 piston hydraulic brake system for MTB and off-road riding
- Short reach lever for smaller hands
- High quality anodised finish
- Self adjusting pistons
- Lever reach adjustment
- International standard and Post mount fit available
- Mineral oil fluid to protect the environment
- Stainless steel rotors
- Spare olives to allow for hose reduction
- Weight - 274g

Complies with and exceeds ISO4210 regulations

Box Contents:

Front and rear sets - 2 x Callipers, 2 x levers, 2 x rotors & bolts, pads & hoses.

Replacement Part Numbers:

Rotor - TL-027 - [See page 35](#)

Pads - VX811, VRX811, VRS811 - [See page 27](#)

Service parts - [See page 86/87](#)

Options available:

Part Numbers:	Description:
M2KFR160PM-AM	Front & Rear 160mm set



- Hydraulic disc brakes 4-17
- Mechanical disc brakes 18-23
- Disc pads 24-29
- Rotors 30-35
- Calliper brackets 36-39
- V-Brakes 40-43
- Brake pads & cartridges 44-49
- Cable kits & wires 50-57
- Cassettes 59
- Chains & accessories 60-61
- Chainrings 62-63
- Bottom brackets 64
- Gears 65
- Grips 66-75
- E-Bike 76-77
- Headsets 78-79
- Hydraulics 80-87
- Service - trays 88-89
- Service - Wire, cable & hose 90-91
- Service - Parts 92-94
- Bottle Cages 95

DISC BRAKES ■ HYDRAULIC

All Clarks hydraulic disc brakes are approved to ISO4210

M3

The M3, delivers superior looks with an alloy cast radial style lever. We have designed the brake to be lightweight, as well as drastically improving the overall aesthetics. The radial design lever increases the room available on the handlebar so creating a cleaner look on the bike. Calliper weight and aesthetics have also benefited from alloy casting as well as the systems ability to deal with heat build-up. The M3 uses 2 pistons per calliper, and with a large internal fluid capacity improving power. The M3 will appeal to many riders from leisure cyclists to the dedicated downhill rider.

- Radial style Flip Flop lever design
- Lightweight cast alloy design
- Removable handle bar clamp
- Lever reach and bite adjustment
- High quality anodised finish
- One piece calliper design
- International standard and Post mount fit
- Mineral oil fluid to protect the environment
- Stainless steel rotors
- Spare olives to allow for hose reduction
- Weight - 224g

Complies with and exceeds IISO4210 regulations

Box Contents:

Front and rear sets - 2 x Callipers, 2 x levers, 2 x rotors & bolts, pads & hoses.

Replacement Part Numbers:

Rotor - TL-027 - [See page 35](#)

Pads - VX852, VRX852, VRS852 - [See page 27](#)

Options available:

Part Numbers:	Description:
M3FR160BAMROW-O	Front & Rear 160mm set
M3FR180BAMROW-O	Front & Rear 180mm set
M3180160BAMROW-O	Front 180mm & Rear 160mm set



POST MOUNT

INTERNATIONAL STANDARD

LIGHTWEIGHT



Hydraulic disc brakes
4-17

Mechanical disc brakes
18-23

Disc pads
24-29

Rotors
30-35

Calliper brackets
36-39

V-Brakes
40-43

Brake pads & cartridges
44-49

Cable kits & wires
50-57

Cassettes
59

Chains & accessories
60-61

Chainrings
62-63

Bottom brackets
64

Gears
65

Grips
66-75

E-Bike
76-77

Headsets
78-79

Hydraulics
80-87

Service - trays
88-89

Service - Wire, cable & hose
90-91

Service - Parts
92-94

Bottle Cages
95



DISC BRAKES ■ HYDRAULIC

All Clarks hydraulic disc brakes are approved to ISO4210

M4

The M4 is a new 4 piston brake system from Clarks. Our most powerful production brake produced to date, the M4 is lightweight with a slimline design, and 4x16mm pistons per calliper, each delivering smooth, powerful, modulated braking force at the rotors. Perfect for all riding conditions encountered by the adventurous downhill rider and e-bikes, the M4 is the ideal brake system for more challenging environments where 'feathering' is required.

- 4 Piston hydraulic brake system for MTB and downhill riders
- Lightweight design
- High quality finish
- Self adjusting pistons 16mm pistons
- 2 Finger lever
- Lever reach adjustment to suit all hand sizes
- International standard and Post mount fit
- Mineral oil fluid to protect the environment
- Stainless steel rotors
- Spare olives to allow for hose reduction
- Weight - 240g

Complies with and exceeds EN15194 and ISO4210 regulations

Box Contents:

Front and rear sets - 2 x Callipers, 2 x levers, 2 x rotors & bolts, pads & hoses.

Replacement Part Numbers:

Rotor - TL-027 - [See page 35](#)

Pads - VX851, VRX851, VRS851 - [See page 27](#)

Options available:

Part Numbers:	Description:
M4F180ISR160ISBROW-O	Front 180mm & Rear 160mm I.S. set
M4F180ISR160ISUK-O	Front 180mm & Rear 160mm I.S. set (UK)
M4F180PMR160ISBROW-O	Front 180mm P.M. & Rear 160mm I.S. set
M4F180PMR160ISUK-O	Front 180mm P.M. & Rear 160mm I.S. set (UK)



- Hydraulic disc brakes 4-17
- Mechanical disc brakes 18-23
- Disc pads 24-29
- Rotors 30-35
- Calliper brackets 36-39
- V-Brakes 40-43
- Brake pads & cartridges 44-49
- Cable kits & wires 50-57
- Cassettes 59
- Chains & accessories 60-61
- Chainrings 62-63
- Bottom brackets 64
- Gears 65
- Grips 66-75
- E-Bike 76-77
- Headsets 78-79
- Hydraulics 80-87
- Service - trays 88-89
- Service - Wire, cable & hose 90-91
- Service - Parts 92-94
- Bottle Cages 95

DISC BRAKES ■ HYDRAULIC

All Clarks hydraulic disc brakes are approved to ISO4210

HD-M3000

Dual Pistons - Open Hydraulic System E brake for Electric bikes, with sensor control design cutting line. **Designed for use on 30km/hr E-bikes**, it consists of a 2 piece forged calliper allowing internal maintenance, the brake is specifically designed for use with E-bikes and has an automatic motor shut off when the brake lever is applied resulting in safe braking. Sensor Control waterproof contact, 3 fingers lever length.

- Designed for use on 30km/hr E-bikes
- Lightweight 2 piston hydraulic brake system
- Motor shut off sensor to give greater control
- Fitted with motor cut off. Juliet Male 8 (2 pin) connector
- 3/4 Finger lever
- Lever reach adjustment to suit all hand sizes
- International standard and Post mount fit
- Mineral oil fluid to protect the environment
- Stainless steel rotors
- Spare olives to allow for hose reduction
- Weight - 280g

Complies with and exceeds EN15194 and ISO4210 regulations

Box Contents:

Front - 1x Calliper, 1 x lever, 1 x rotor & bolts, pads & hose.
Rear - 1x Calliper, 1 x lever, 1 x rotor & bolts, pads & hose.

Replacement Part Numbers:

Rotor - TL-027 - [See page 35](#)
 Pads - VX811, VRX811, EVRS811 - [See page 27](#)

Options available:

Part Numbers:	Description:
HD-M3000F900-250-160-AM	Front 160mm
HD-M3000R1750-250-160-AM	Rear 160mm



Hydraulic disc brakes
4-17

Mechanical disc brakes
18-23

Disc pads
24-29

Rotors
30-35

Calliper brackets
36-39

V-Brakes
40-43

Brake pads & cartridges
44-49

Cable kits & wires
50-57

Cassettes
59

Chains & accessories
60-61

Chainrings
62-63

Bottom brackets
64

Gears
65

Grips
66-75

E-Bike
76-77

Headsets
78-79

Hydraulics
80-87

Service - trays
88-89

Service - Wire, cable & hose
90-91

Service - Parts
92-94

Bottle Cages
95

DISC BRAKES ■ HYDRAULIC

All Clarks hydraulic disc brakes are approved to ISO4210

HD-M3000 PLUS

Dual Pistons - Open Hydraulic System E brake for Electric bikes, with sensor control design cutting line. **Designed for use on 45km/hr E-bikes**, it consists of a 2 piece forged calliper allowing internal maintenance, the brake is specifically designed for use with E-bikes and has an automatic motor shut off when the brake lever is applied resulting in safe braking. Sensor Control waterproof contact, 3 fingers lever length.

- Designed for use on 45km/hr E-bikes
- Lightweight 2 piston hydraulic brake system
- Motor shut off sensor to give greater control
- Fitted with motor cut off. Juliet Male 8 (2 pin) connector
- 3/4 Finger lever
- Lever reach adjustment to suit all hand sizes
- International standard and Post mount fit
- Mineral oil fluid to protect the environment
- Stainless steel rotors
- Spare olives to allow for hose reduction
- Weight - 280g

Complies with and exceeds EN15194 and ISO4210 regulations

Box Contents:

Front - 1x Calliper, 1 x lever, 1 x rotor & bolts, pads & hose.
Rear - 1x Calliper, 1 x lever, 1 x rotor & bolts, pads & hose.

Replacement Part Numbers:

Rotor - TL-027 - [See page 35](#)
 Pads - VX811, VRX811, EVRS811 - [See page 27](#)

Options available:

Part Numbers:	Description:
HDM3000PF180PMR160ISROWAM	Front 180mm & Rear 160mm I.S. set
HDM3000PF180PMR160ISUKAM	Front 180mm & Rear 160mm I.S. set (UK)



- Hydraulic disc brakes 4-17
- Mechanical disc brakes 18-23
- Disc pads 24-29
- Rotors 30-35
- Calliper brackets 36-39
- V-Brakes 40-43
- Brake pads & cartridges 44-49
- Cable kits & wires 50-57
- Cassettes 59
- Chains & accessories 60-61
- Chainrings 62-63
- Bottom brackets 64
- Gears 65
- Grips 66-75
- E-Bike 76-77
- Headsets 78-79
- Hydraulics 80-87
- Service - trays 88-89
- Service - Wire, cable & hose 90-91
- Service - Parts 92-94
- Bottle Cages 95

DISC BRAKES ■ HYDRAULIC

All Clarks hydraulic disc brakes are approved to ISO4210

e-CLOUT

The e-Clout, Clarks new hydraulic brake system has 22mm pistons which provide greater power and control. These self adjusting pistons provide greater stopping force making it the ideal brake set for E-bikes and MTB's. Built on the success of the M Series brake sets, the e-Clout features semi-metallic pads, for improved wear and control, lever reach adjustment and mineral oil fluid.

- Lightweight brake system for E-bikes and MTB's
- Self adjusting 22mm calliper pistons for greater stopping force
- 3 Finger lever for greater braking force and control at the lever
- Semi-metallic pads for improved wear characteristics & control
- Lever reach adjustment to suit all hand sizes
- International standard and Post mount fit
- Mineral oil fluid to protect the environment
- Stainless steel rotors
- Spare olives to allow for hose reduction
- Weight - 300g

Complies with and exceeds EN15194 and ISO4210 regulations

Box Contents:

Front and rear sets - 2 x Callipers, 2 x levers, 2 x rotors & bolts, pads & hoses.

Replacement Part Numbers:

Rotor - TL-027 - See page 35

Pads - VX811, VRX811, EVRS811 - See page 27

Options available:

Part Numbers:	Description:
HY21EF180PMR160ISBAMROW	Front 180mm PM Rear 160mm I.S. set



Hydraulic disc brakes
4-17

Mechanical disc brakes
18-23

Disc pads
24-29

Rotors
30-35

Calliper brackets
36-39

V-Brakes
40-43

Brake pads & cartridges
44-49

Cable kits & wires
50-57

Cassettes
59

Chains & accessories
60-61

Chainrings
62-63

Bottom brackets
64

Gears
65

Grips
66-75

E-Bike
76-77

Headsets
78-79

Hydraulics
80-87

Service - trays
88-89

Service - Wire, cable & hose
90-91

Service - Parts
92-94

Bottle Cages
95

DISC BRAKES ■ SEMI-HYDRAULIC

All Clarks hydraulic disc brakes are approved to ISO4210

CHM-08

Clarks Semi hydraulic flat mount disc brake has the advantage of hydraulic power but is operated using cables and so can be fitted to road as well as MTB bikes. Tested to ISO 4210 it features heat cooling vents and light weight floating rotors for more efficient operation and consistent braking performance.

- Compatible with Road, Cyclo-cross and Gravel bikes
- Advantage of hydraulic power and parallel braking
- 2 piston hydraulic activated brake.
- Lightweight brake
- Mineral oil.
- Flat mount fit.
- Heat cooling vents on disc pads
- Light floating rotors, alloy and aviation stainless steel
- Lightweight 134g

Complies with and exceeds ISO4210 regulations

Box Contents:

Front and rear sets - 2 x Callipers, 2 x rotors, 12 x rotor bolts & pads.

Replacement Part Numbers:

Pads - VX811, VRX811, VRS811 - See page 27

Options available:

Part Numbers:	Description:
CHM-8F140R140	Front & Rear 140mm set
CHM-8F160R160	Front & Rear 160mm set



- Hydraulic disc brakes 4-17
- Mechanical disc brakes 18-23
- Disc pads 24-29
- Rotors 30-35
- Calliper brackets 36-39
- V-Brakes 40-43
- Brake pads & cartridges 44-49
- Cable kits & wires 50-57
- Cassettes 59
- Chains & accessories 60-61
- Chainrings 62-63
- Bottom brackets 64
- Gears 65
- Grips 66-75
- E-Bike 76-77
- Headsets 78-79
- Hydraulics 80-87
- Service - trays 88-89
- Service - Wire, cable & hose 90-91
- Service - Parts 92-94
- Bottle Cages 95

DISC BRAKES ■ SEMI-HYDRAULIC

All Clarks hydraulic disc brakes are approved to ISO4210

CHM-05

Clarks semi-hydraulic flat mount disc brake has the advantage of hydraulic power but is operated using cables and so can be fitted to road as well as MTB bikes. Suitable for cross bikes and road bikes, tested to ISO 4210 it includes lightweight floating rotors for more efficient operation and consistent braking performance. Large 22mm diameter pistons provide greater braking force.

- Compatible with Road, Cyclo-cross and Gravel bikes
- Advantage of hydraulic power and parallel braking
- 2 piston hydraulic activated brake.
- Lightweight brake
- Mineral oil.
- Flat mount fit.
- Large 22mm diameter
- Light floating rotors, alloy and aviation stainless steel
- Lightweight 134g

Complies with and exceeds ISO4210 regulations

Box Contents:

Front and rear sets - 2 x Callipers, 2 x rotors, 12 x rotor bolts & pads.

Replacement Part Numbers:

Pads - VX862, VRX862, VRS862 - See page 29

Options available:

Part Numbers:	Description:
CHM-05F160R140	Front 160mm & Rear 140mm set



Hydraulic disc brakes
4-17

Mechanical disc brakes
18-23

Disc pads
24-29

Rotors
30-35

Calliper brackets
36-39

V-Brakes
40-43

Brake pads & cartridges
44-49

Cable kits & wires
50-57

Cassettes
59

Chains & accessories
60-61

Chainrings
62-63

Bottom brackets
64

Gears
65

Grips
66-75

E-Bike
76-77

Headsets
78-79

Hydraulics
80-87

Service - trays
88-89

Service - Wire, cable & hose
90-91

Service - Parts
92-94

Bottle Cages
95



MECHANICAL DISC BRAKES

Mechanical Disc brakes offer the cyclist all the benefits of powerful all weather braking but without the more complex maintenance requirements of hydraulic brake systems. Cable operated brake callipers provide consistent braking performance that is better than wheel rim based braking systems due to the position of the hub mounted braking surface. Positioned away from road dirt and traffic film, these systems are ideal for hybrid and road cyclists who require reliable braking but without excess weight and maintenance problems. All our mechanical brakes are supplied with Post Mount and International Standard mounting brackets, bolts callipers and rotors.



**SERVICE &
REPAIR PARTS**

clarks.bike/order-spare-parts.html



**SERVICE &
FITTING VIDEOS**

clarks.bike/how-to-videos.html



PRODUCT HELPLINE
info@clarks.bike

+44 (0)1455 254800

Hydraulic disc brakes
4-17

Mechanical disc brakes
18-23

Disc pads
24-29

Rotors
30-35

Calliper brackets
36-39

V-Brakes
40-43

Brake pads & cartridges
44-49

Cable kits & wires
50-57

Cassettes
59

Chains & accessories
60-61

Chainrings
62-63

Bottom brackets
64

Gears
65

Grips
66-75

E-Bike
76-77

Headsets
78-79

Hydraulics
80-87

Service - trays
88-89

Service - Wire, cable & hose
90-91

Service - Parts
92-94

Bottle Cages
95

RECOMMENDED TORQUE SETTINGS

Below are recommended torque settings for our Mechanical and Hydraulic brake systems. For more information and 'How to Video's' please visit www.clarks.bike

Fitting Position	Fitting Size	Torque Setting
Rotor bolt	Torx T25	6.2 NM
Calliper to bracket bolt	M6 bolt	11-13 NM
Lever bracket bolt	M6 bolt	6-8 NM
Bracket to frame bolt	M6 bolt	11-13 NM
Lever hose compression nut	8mm	9 NM
C-Jet	-	6-8 NM



EASY FIT



LIGHTWEIGHT



POST MOUNT



INTERNATIONAL STANDARD

CLARKS

DISC BRAKES ■ MECHANICAL

All Clarks mechanical disc brakes are approved to ISO4210

CMD-21

The CMD-21 is a lightweight mechanical brake that is suitable for use with Hybrid / MTB Bikes, the callipers are lightweight in design and feature a built in pad adjustment that will ensure a perfect brake setup. The CMD-21 is supplied in a full bike set which includes front and rear callipers with lightweight rotors and 2 sets of extra disc pads. All supplied in an after market presentation box.

- Compatible with Hybrid and MTB bikes
- IS & PM compatible
- Single piece calliper design
- Easy pad adjustment
- Integrated cable tensioner
- Includes 2 extra pairs of pads



Box Contents:

Front and rear sets - 2 x Callipers, 2 x rotors, 12 x rotor bolts & 2 extra pairs of pads.

Replacement Part Numbers:

Rotor - CL-160 - See page 35
 Pads - VX865 - See page 27

Options available:

Part Numbers:	Description:
CMD-21-F&R-160/160	Front & Rear 160mm set
CMD-21-F&R-160/140	Front 160mm & Rear 140mm set

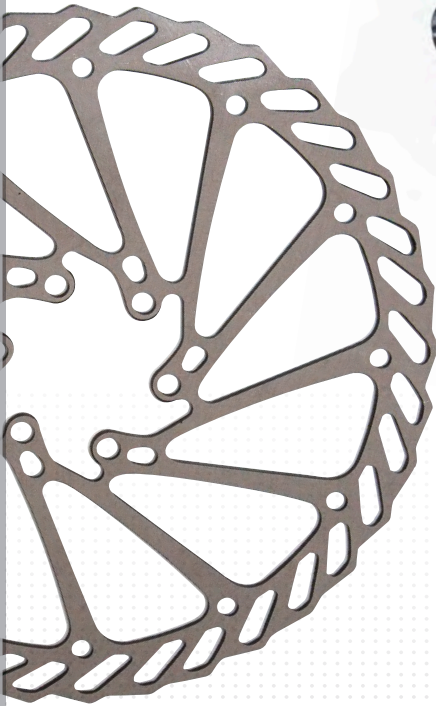

- Hydraulic disc brakes 4-17
- Mechanical disc brakes 18-23
- Disc pads 24-29
- Rotors 30-35
- Calliper brackets 36-39
- V-Brakes 40-43
- Brake pads & cartridges 44-49
- Cable kits & wires 50-57
- Cassettes 59
- Chains & accessories 60-61
- Chainrings 62-63
- Bottom brackets 64
- Gears 65
- Grips 66-75
- E-Bike 76-77
- Headsets 78-79
- Hydraulics 80-87
- Service - trays 88-89
- Service - Wire, cable & hose 90-91
- Service - Parts 92-94
- Bottle Cages 95

DISC BRAKES ■ MECHANICAL

All Clarks mechanical disc brakes are approved to ISO4210

CMD-23

The CMD 23 mechanical disc brake offers powerful braking consistency in wet and dry conditions. Suitable for MTB and hybrid bikes. Available in sets, front and rear, with 160mm rotors. The brake is made to very high standards, surpassing CEN regulations, with a large brake pad area providing greater braking power.

- Compatible with MTB/Hybrid bikes
- IS & PM compatible
- Lightweight design

Box Contents:

Front and rear sets - 2 x Callipers, 2 x rotors, 12 x rotor bolts & pads.

Replacement Part Numbers:

Rotor - CL-160 - See page 35

Pads - VX811, VRX811, VRS811 - See page 27

Options available:

Part Numbers:	Description:
CMD-23-F&R-160	Front & Rear 160mm set

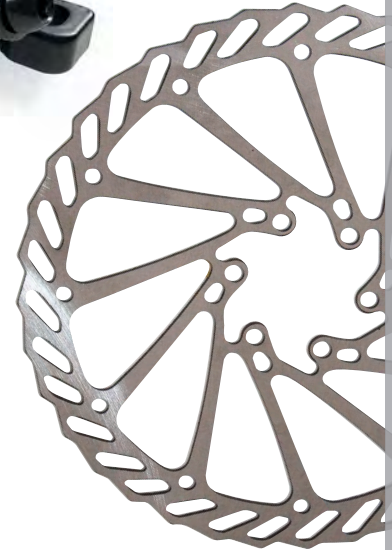

CMD-24

Clarks E-Bike mechanical disc brake calliper, manufactured in aluminium alloy, features wider disc pads for greater efficiency and stopping power.

- Suitable for e-bikes
- Compatible with MTB/Hybrid bikes
- IS & PM compatible
- Lightweight design
- Built in adjustment
- Lightweight 269g (including rotor)

Box Contents:

Front and rear sets - 2 x Callipers, 2 x rotors, 12 x rotor bolts & pads.

Replacement Part Numbers:

Rotor - TL-027 - See page 35

Pads - VX824, VRX824, VRS824 - See page 27

Options available:

Part Numbers:	Description:
CMD-24-F&R-180/160	Front 180 & Rear 160mm set



Hydraulic disc brakes
4-17

Mechanical disc brakes
18-23

Disc pads
24-29

Rotors
30-35

Calliper brackets
36-39

V-Brakes
40-43

Brake pads & cartridges
44-49

Cable kits & wires
50-57

Cassettes
59

Chains & accessories
60-61

Chainrings
62-63

Bottom brackets
64

Gears
65

Grips
66-75

E-Bike
76-77

Headsets
78-79

Hydraulics
80-87

Service - trays
88-89

Service - Wire, cable & hose
90-91

Service - Parts
92-94

Bottle Cages
95



DISC BRAKES ■ MECHANICAL

All Clarks mechanical disc brakes are approved to ISO4210

CMD-25

Clarks new CMD-25 E-Bike mechanical disc brake calliper, features a single piece calliper, CNC machined in aluminium alloy for extra strength. In order to generate the additional braking forces required for e-bikes and EAPC's, the CMD-25 has self-aligning sintered pads, ensuring full contact with the rotor at all times.

- E-Bike approved - Tested and approved to EN 15194 and EAPC (Electrically Assisted Pedal Cycles)
- CNC machined, single piece calliper for additional strength
- Self-aligning pads providing full rotor contact
- VRX811 Sintered disc pads for greater stopping power
- Cable adjuster

Box Contents:

Front and rear sets - 2 x Callipers, 2 x rotors, 12 x rotor bolts & VRX pads.

Replacement Part Numbers:

Rotor - TL-027 - See page 35

Pads - VX811, VRX811, VRS811 - See page 27

Options available:

Part Numbers:	Description:
CMD-25F180PMISR160ISAM	Front 180 & Rear 160mm set

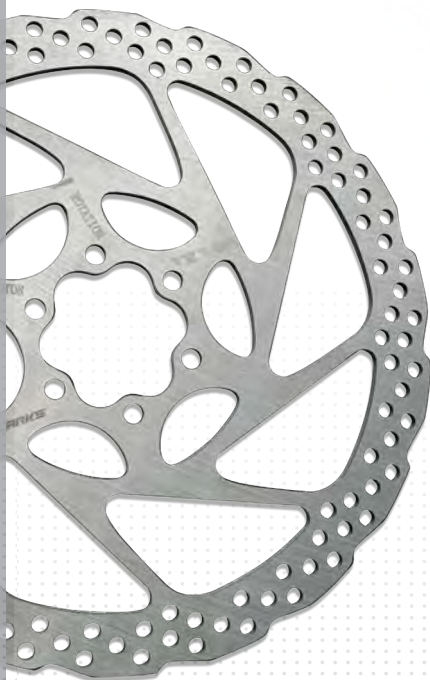

- Hydraulic disc brakes 4-17
- Mechanical disc brakes 18-23
- Disc pads 24-29
- Rotors 30-35
- Calliper brackets 36-39
- V-Brakes 40-43
- Brake pads & cartridges 44-49
- Cable kits & wires 50-57
- Cassettes 59
- Chains & accessories 60-61
- Chainrings 62-63
- Bottom brackets 64
- Gears 65
- Grips 66-75
- E-Bike 76-77
- Headsets 78-79
- Hydraulics 80-87
- Service - trays 88-89
- Service - Wire, cable & hose 90-91
- Service - Parts 92-94
- Bottle Cages 95

DISC BRAKES ■ MECHANICAL

All Clarks mechanical disc brakes are approved to ISO4210

CMD-28FM

The New CMD-28FM flat mount mechanical disc brake is suitable for road, cyclo-cross, hybrid, gravel and drop bar bikes. The callipers are lightweight in design and feature a built in pad adjustment that will ensure a perfect brake setup. The CMD-28 is supplied in a full bike set which includes front and rear callipers with lightweight rotors.

- Compatible with Road, Cyclo-cross and Gravel bikes
- Flat mount fit
- Lightweight design
- Built in adjustment
- High grade material construction

Box Contents:

Front and rear sets - 2 x Callipers, 2 x rotors, 12 x rotor bolts & VRX pads.

Replacement Part Numbers:

Rotor - CL-160 - See page 35

Pads - VX811, VRX811, VRS811 - See page 27

Options available:

Part Numbers:	Description:
CMD-28FMF160FMR140FM	Front 160 & Rear 140mm set

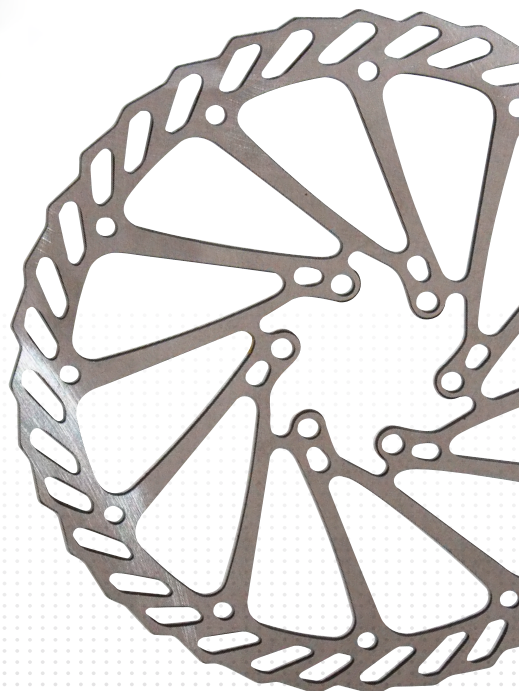

Hydraulic disc brakes
4-17

Mechanical disc brakes
18-23

Disc pads
24-29

Rotors
30-35

Calliper brackets
36-39

V-Brakes
40-43

Brake pads & cartridges
44-49

Cable kits & wires
50-57

Cassettes
59

Chains & accessories
60-61

Chainrings
62-63

Bottom brackets
64

Gears
65

Grips
66-75

E-Bike
76-77

Headsets
78-79

Hydraulics
80-87

Service - trays
88-89

Service - Wire, cable & hose
90-91

Service - Parts
92-94

Bottle Cages
95



DISC PADS

Clarks disc pads have been engineered for every style of riding in all conditions. Our range is comprehensive, compatible with all the major manufacturers' current and older braking systems. We offer the rider three types of pad compound. All pads are tested to ISO4210 and demonstrate unrivalled stopping power and longevity. Springs and split pins are included with every pad set, where applicable.



SERVICE & REPAIR PARTS

clarks.bike/order-spare-parts.html



SERVICE & FITTING VIDEOS

clarks.bike/how-to-videos.html



PRODUCT HELPLINE
info@clarks.bike

+44 (0)1455 254800

ENTHUSIAST

VX [ORGANIC]

Specifically designed to give the best performance under normal conditions. The organic compound provides, 'pre-bedded in' pads, improves noise reduction and increases 'bite'.



QUICK BED IN

TRAIL, DOWNHILL

VRX [SINTERED]

Harder compound pad with increased carbon content, sintered pads are designed to deliver maximum performance under stress and extreme conditions. Consistent through sustained riding they are ideal for hydraulic brake systems.



LONG LIFE



HEAT DISSIPATION

COMPETITION

VRS [SEMI-METALLIC]

The VRS pads are specifically engineered for competition riding: with an advanced pad compound comprising of, Kevlar® for high frictional properties, high ceramic content for improved wet weather performance and a increased copper content for superior low speed braking characteristics. In addition a 'grooved' backing plate improves the airflow between the piston and the pad, keeping the brake system cooler and performance consistent.



COMPETITION



HEAT DISSIPATION



LIGHTWEIGHT

E-BIKE

E-VRS [SEMI-METALLIC]

The E-VRS disc brake pads have a high carbon content for E-bike disc brakes. The pad compound is specifically suitable for E-bikes, having high brass/iron content for powerful braking performance. Packaged in bike sets of 2 pairs and clips.

[SEE PAGE 73](#)



Hydraulic disc brakes
4-17

Mechanical disc brakes
18-23

Disc pads
24-29

Rotors
30-35

Calliper brackets
36-39

V-Brakes
40-43

Brake pads & cartridges
44-49

Cable kits & wires
50-57

Cassettes
59

Chains & accessories
60-61

Chainrings
62-63

Bottom brackets
64

Gears
65

Grips
66-75

E-Bike
76-77

Headsets
78-79

Hydraulics
80-87

Service - trays
88-89

Service - Wire, cable & hose
90-91

Service - Parts
92-94

Bottle Cages
95

CLARKS

DISC PADS FINNED

Clarks finned disc brake pad carriers feature a unique design that helps to transfer heat build-up in the disc pad backing plate into the Fins. This significantly increases heat dissipation, reducing the brake pad surface temperature. By lowering the pad temperature the rider benefits from increased power, increased performance and consistent modulation.

Clarks Finned carriers cannot be used with standard pads. The finned carrier will only accept Clarks replacement finned pads which have a thinner backing plate that has been reinforced with Kevlar® for extra strength.



VX/VRX824-FIN
Carrier and replacement pads

Options

Compatibility - Shimano XTR pre 2011

Part Numbers:	Description:
VX824-FIN	Carrier
VX824-FIN-RE	Replacement Organic pads
VRX824-FIN-RE	Replacement Sintered pads



VX/VRX841-FIN
Carrier and replacement pads

Options

Compatibility - Avid Elixir DB

Part Numbers:	Description:
VX841-FIN	Carrier
VX841-FIN-RE	Replacement Organic pads
VRX841-FIN-RE	Replacement Sintered pads



VX/VRX850-FIN
Carrier and replacement pads

Options

Compatibility - Formula Mega, The one, R

Part Numbers:	Description:
VX850-FIN	Carrier
VX850-FIN-RE	Replacement Organic pads
VRX850-FIN-RE	Replacement Sintered pads



VX/VRX851-FIN
Carrier and replacement pads

Options

Compatibility - Shimano Saint and Zee

Part Numbers:	Description:
VX851-FIN	Carrier
VX851-FIN-RE	Replacement Organic pads
VRX851-FIN-RE	Replacement Sintered pads



VX/VRX852-FIN
Carrier and replacement pads

Options

Compatibility - Shimano XTR

Part Numbers:	Description:
VX852-FIN	Carrier
VX852-FIN-RE	Replacement Organic pads
VRX852-FIN-RE	Replacement Sintered pads



VX/VRX857-FIN
Carrier and replacement pads

Options

Compatibility - Magura MT, 2, 4, 6, 8.

Part Numbers:	Description:
VX857-FIN	Carrier
VX857-FIN-RE	Replacement Organic pads
VRX857-FIN-RE	Replacement Sintered pads



VX/VRX858-FIN
Carrier and replacement pads

Options

Compatibility - Avid Code 2011

Part Numbers:	Description:
VX858-FIN	Carrier
VX858-FIN-RE	Replacement Organic pads
VRX858-FIN-RE	Replacement Sintered pads



VX/VRX859-FIN
Carrier and replacement pads

Options

Compatibility - Avid X0, Elixir 7 Trail, Elixir 9 Trail. SRAM Guide

Part Numbers:	Description:
VX859-FIN	Carrier
VX859-FIN-RE	Replacement Organic pads
VRX859-FIN-RE	Replacement Sintered pads

- Hydraulic disc brakes 4-17
- Mechanical disc brakes 18-23
- Disc pads 24-29
- Rotors 30-35
- Calliper brackets 36-39
- V-Brakes 40-43
- Brake pads & cartridges 44-49
- Cable kits & wires 50-57
- Cassettes 59
- Chains & accessories 60-61
- Chainrings 62-63
- Bottom brackets 64
- Gears 65
- Grips 66-75
- E-Bike 76-77
- Headsets 78-79
- Hydraulics 80-87
- Service - trays 88-89
- Service - Wire, cable & hose 90-91
- Service - Parts 92-94
- Bottle Cages 95

DISC PADS

Springs and clip pins are included with every pad set - where applicable.

AVID/SRAM



VX/VRX/VRS813

Compatibility - Avid Juicy 3, 5, 7, 7 Carbon, Ultimate, BB7

Part Numbers:	Description:
VX813	Organic
VRX813	Sintered
VRS813	Competition



VX/VRX834

Compatibility - Avid Code, Spring Inc

Part Numbers:	Description:
VX834	Organic
VRX834	Sintered



VX/VRX/VRS839

Compatibility - Avid BB5

Part Numbers:	Description:
VX839	Organic
VRX839	Sintered
VRS839	Competition



VX/VRX/VRS841

Compatibility - Avid Elixir 1, 3, 5, 7, Elixir R, Elixir CR,

Part Numbers:	Description:
VX841	Organic
VRX841	Sintered
VRS841	Competition



VX/VRX/VRS858

Compatibility - Avid Code 2011 Onwards, Code-R

Part Numbers:	Description:
VX858	Organic
VRX858	Sintered

AVID/SRAM



VX/VRX/VRS859

Compatibility - Avid XO, Elixir 7 Trail, Elixir 9 Trail SRAM Guide

Part Numbers:	Description:
VX859	Organic
VRX859	Sintered
VRS859	Competition



VX/VRX/VRS811

Compatibility - S2, Clout, e-Clout, Clout Plus, **M2 (2021 batch F & O)** CMD-23, CMD-27, HD-M3000 CHM-08, CMD-25, CMD-28

Part Numbers:	Description:
VX811	Organic
VRX811	Sintered
VRS811	Competition



VX/VRX/VRS813

Compatibility - CMD-15

Part Numbers:	Description:
VX813	Organic
VRX813	Sintered
VRS813	Competition



VX/VRX/VRS815

Compatibility - EXO, Skeletal

Part Numbers:	Description:
VX815	Organic
VRX815	Sintered
VRS815	Competition



VX/VRX/VRS824

Compatibility - HDB540, 600, 790, CMD-24

Part Numbers:	Description:
VX824	Organic
VRX824	Sintered
VRS824	Competition

CLARKS



VX838

Compatibility - CMD-9

Part Numbers:	Description:
VX838	Organic



VX/VRX839

Compatibility - CMD-17, CMD-17R

Part Numbers:	Description:
VX839	Organic
VRX839	Sintered
VRS839	Competition



VX840

Compatibility - CMD-5, CMD-6, CMD-7, CMD-12

Part Numbers:	Description:
VX840	Organic



VX849

Compatibility - CMD-8, CMD-11 CMD-16, Carrera Impel is-1 scooter

Part Numbers:	Description:
VX849	Organic



VX/VRX/VRS851

Compatibility - M4

Part Numbers:	Description:
VX851	Organic
VRX851	Sintered
VRS851	Competition

CLARKS



VX/VRX/VRS852

Compatibility - M1, **M2 (2021 batch L)** M3, CMD-22, CMD-22FM, CHM-08

Part Numbers:	Description:
VX852	Organic
VRX852	Sintered
VRS852	Competition



VX/VRX865

Compatibility - CMD-19, CMD-20, CMD-21

Part Numbers:	Description:
VX865	Organic
VRX865	Sintered



VX/VRX809

Compatibility - B4, Pro/SL

Part Numbers:	Description:
VX809	Organic
VRX809	Sintered



VX/VRX/VRS833

Compatibility - Oro

Part Numbers:	Description:
VX833	Organic
VRX833	Sintered
VRS833	Competition



VX/VRX/VRS850

Compatibility - R1, The One, Mega, RX, RO, T1

Part Numbers:	Description:
VX850	Organic
VRX850	Sintered
VRS850	Competition

Hydraulic disc brakes 4-17

Mechanical disc brakes 18-23

Disc pads 24-29

Rotors 30-35

Calliper brackets 36-39

V-Brakes 40-43

Brake pads & cartridges 44-49

Cable kits & wires 50-57

Cassettes 59

Chains & accessories 60-61

Chainrings 62-63

Bottom brackets 64

Gears 65

Grips 66-75

E-Bike 76-77

Headsets 78-79

Hydraulics 80-87

Service - trays 88-89

Service - Wire, cable & hose 90-91

Service - Parts 92-94

Bottle Cages 95

DISC PADS

Springs and clip pins are included with every pad set - where applicable.

HAYES



VX/VRX/VRS814
Compatibility - HFX1-HFX-9

Part Numbers:	Description:
VX814	Organic
VRX814	Sintered
VRS814	Competition



VX/VRX828
Compatibility - Sole, GX-2, MX1, MX2, MX3, MX4

Part Numbers:	Description:
VX828	Organic
VRX828	Sintered



VX/VRX842
Compatibility - Stroker Trail

Part Numbers:	Description:
VX842	Organic
VRX842	Sintered



VX/VRX/VRS843
Compatibility - Stroker Ryde - Dyno

Part Numbers:	Description:
VX843	Organic
VRX843	Sintered
VRS843	Competition



VX/VRX856
Compatibility - Prime

Part Numbers:	Description:
VX856	Organic
VRX856	Sintered

HOPE



VX/VRX/VRS801
Compatibility - Mono 4 & 5

Part Numbers:	Description:
VX801	Organic
VRX801	Sintered
VRS801	Competition



VX/VRX806
Compatibility - C2, Pro/Sport

Part Numbers:	Description:
VX806	Organic
VRX806	Sintered



VX/VRX812
Compatibility - Hope Mini

Part Numbers:	Description:
VX812	Organic
VRX812	Sintered



VX/VRX826
Compatibility - Mono Mini

Part Numbers:	Description:
VX826	Organic
VRX826	Sintered



VX/VRX855
Compatibility - M4, DH4, Enduro 4

Part Numbers:	Description:
VX855	Organic
VRX855	Sintered

HOPE



VX/VRX861
Compatibility - E4

Part Numbers:	Description:
VX861	Organic
VRX861	Sintered



VX/VRX800
Compatibility - Clara 2000, Louise 1999-2001

Part Numbers:	Description:
VX800	Organic
VRX800	Sintered



VX/VRX807
Compatibility - Clara 2001-02, Louise FR, Louise 2002-06.

Part Numbers:	Description:
VX807	Organic
VRX807	Sintered



VX/VRX808
Compatibility - Julie 2001-2008

Part Numbers:	Description:
VX808	Organic
VRX808	Sintered



VX/VRX/VRS815
Compatibility - Magura Marta 2002-2008, Marta SL

Part Numbers:	Description:
VX815	Organic
VRX815	Sintered

MAGURA



VX/VRX846
Compatibility - All Martas 2009, All Louise 2007/Carbon 2008, Julie HP

Part Numbers:	Description:
VX846	Organic
VRX846	Sintered



VX/VRX/VRS857
Compatibility - MT2, MT4, MT6, MT8

Part Numbers:	Description:
VX857	Organic
VRX857	Sintered
VRS857	Competition



VX/VRX/VRS866
Compatibility - MT5, MT7 (Packaged in sets of 2 pairs)

Part Numbers:	Description:
VX866	Organic
VRX866	Sintered
VRS866	Competition

PROMAX



VX/VRX829
Compatibility - DSK320, DSK400, DSK-610J, DSK-50J, DSK700, XNine

Part Numbers:	Description:
VX829	Organic
VRX829	Sintered

SRAM/AVID



VX/VRX/VRS801
Compatibility - 9.0

Part Numbers:	Description:
VX801	Organic
VRX801	Sintered
VRS801	Competition

- Hydraulic disc brakes 4-17
- Mechanical disc brakes 18-23
- Disc pads 24-29
- Rotors 30-35
- Calliper brackets 36-39
- V-Brakes 40-43
- Brake pads & cartridges 44-49
- Cable kits & wires 50-57
- Cassettes 59
- Chains & accessories 60-61
- Chainrings 62-63
- Bottom brackets 64
- Gears 65
- Grips 66-75
- E-Bike 76-77
- Headsets 78-79
- Hydraulics 80-87
- Service - trays 88-89
- Service - Wire, cable & hose 90-91
- Service - Parts 92-94
- Bottle Cages 95

DISC PADS

Springs and clip pins are included with every pad set - where applicable.

SRAM/AVID



VX/VRX/VRS841
Compatibility -
XX, X0

Part Numbers:	Description:
VX841	Organic
VRX841	Sintered
VRS841	Competition



VX/VRX/VRS864
Compatibility -
DB-1, DB-3, DB-5

Part Numbers:	Description:
VX864	Organic
VRX864	Sintered



VX/VRX/VRS859
Compatibility -
SRAM Guide

Part Numbers:	Description:
VX859	Organic
VRX859	Sintered
VRS859	Competition



VX/VRX/VRS860
Compatibility -
Rival 22, Force 22,
Red 22, HRD

Part Numbers:	Description:
VX860	Organic
VRX860	Sintered
VRS860	Competition



VX/VRX/VRS811
Compatibility - Draco,
Dorado, Orion, Auriga,
Aquila, HDC300, TRP -
Spyre, Hylex

Part Numbers:	Description:
VX811	Organic
VRX811	Sintered
VRS811	Competition

TEKTRO & TRP



VX844
Compatibility -
Tektro Lo

Part Numbers:	Description:
VX844	Organic



VX/VRX845
Compatibility -
Tektro Lyra, IOX

Part Numbers:	Description:
VX845	Organic
VRX845	Sintered



VX853
Compatibility -
Tektro Novela 2011
onwards

Part Numbers:	Description:
VX853	Organic



VX854
Compatibility -
Volans, Auriga Twin,
Auriga Sub, Auriga E-Sub

Part Numbers:	Description:
VX854	Organic



VX/VRX863
Compatibility -
Tektro Dorado

Part Numbers:	Description:
VX863	Organic
VRX863	Sintered

SHIMANO



VX/VRX/VRS801
Compatibility -
Deore, Deore XT
XT 755-756, M775

Part Numbers:	Description:
VX801	Organic
VRX801	Sintered
VRS801	Competition



VX/VRX810
Compatibility -
Deore M555

Part Numbers:	Description:
VX810	Organic
VRX810	Sintered



VX/VRX/VRS811
Compatibility -
(BR-M515, M475, M525,
M465, M495)

Part Numbers:	Description:
VX811	Organic
VRX811	Sintered
VRS811	Competition



VX/VRX/VRS824
Compatibility - XTR,
XT, SLX, Alfine, Deore
XT, M601, M765,
M585, M858, M965/966

Part Numbers:	Description:
VX824	Organic
VRX824	Sintered
VRS824	Competition



VX/VRX/VRS851
Compatibility -
XTR, Deore XT, SLX,
Saint, Zee, M810-M820/
M640

Part Numbers:	Description:
VX851	Organic
VRX851	Sintered
VRS851	Competition

SHIMANO



VX/VRX/VRS852
Compatibility - XTR, Deore
XT, SLX, Alfine, M985, M987,
M988, M975, M965 - M785,
M666, M675 - M615, S700,
S700 R785

Part Numbers:	Description:
VX852	Organic
VRX852	Sintered
VRS852	Competition



VX/VRX/VRS858
Compatibility -
XT 755-756

Part Numbers:	Description:
VX858	Organic
VRX858	Sintered
VRS858	Competition



VX/VRX862
Compatibility -
XTR, Dura-Ace, Ultegra, 105,
Tiagra, GRX, BR-RS805, BR-
RS505, Clarks CHM-05

Part Numbers:	Description:
VX862	Organic
VRX862	Sintered

ZOOM, SCOOTERS



VX836
Compatibility - Apse
Zoom / Artek for Apollo
Shockwave & X-Rated
Xiaomi Scooters

Part Numbers:	Description:
VX836	Organic

Boxes of 25

All disc pads are available in boxes of 25, including springs and clip pins where applicable.

Hydraulic disc brakes
4-17

Mechanical disc brakes
18-23

Disc pads
24-29

Rotors
30-35

Calliper brackets
36-39

V-Brakes
40-43

Brake pads & cartridges
44-49

Cable kits & wires
50-57

Cassettes
59

Chains & accessories
60-61

Chainrings
62-63

Bottom brackets
64

Gears
65

Grips
66-75

E-Bike
76-77

Headsets
78-79

Hydraulics
80-87

Service -
trays
88-89

Service -
Wire, cable & hose
90-91

Service -
Parts
92-94

Bottle Cages
95



CLARKS
EXCEED YOUR LIMITATIONS

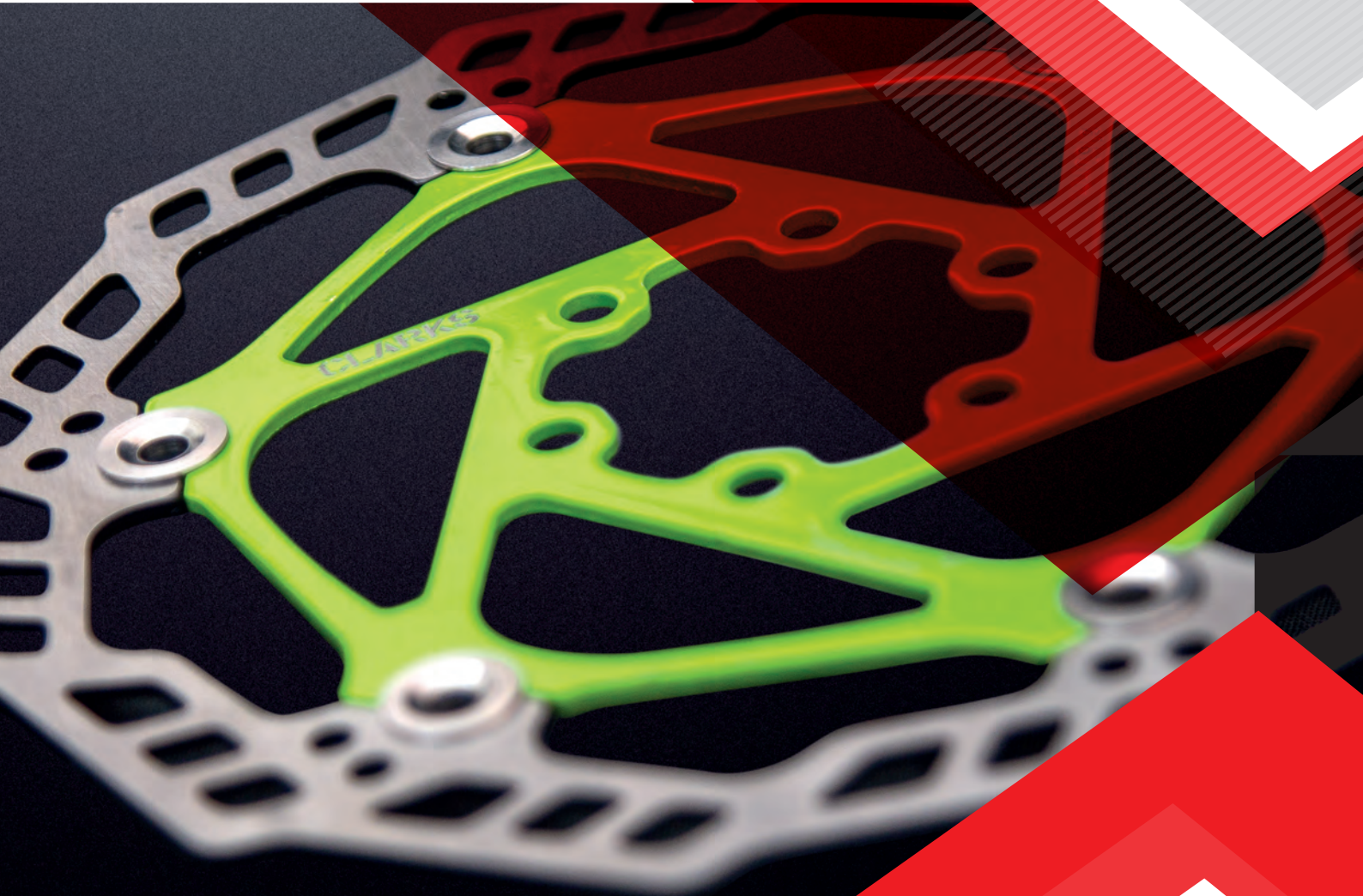

ROTORS

We carry a range of fixed and floating rotors. All are manufactured to high standards and available in a full range of sizes, from 140mm diameter through to 203mm diameter. Our floating rotor designs feature both stainless steel and aluminium carriers which significantly reduce heat transfer to the wheel hub and reduce brake fade.



SERVICE & REPAIR PARTS

clarks.bike/order-spare-parts.html



SERVICE & FITTING VIDEOS

clarks.bike/how-to-videos.html



PRODUCT HELPLINE
info@clarks.bike

+44 (0)1455 254800



- Hydraulic disc brakes 4-17
- Mechanical disc brakes 18-23
- Disc pads 24-29
- Rotors 30-35

ROTOR BOLT TIGHTENING SEQUENCE



RECOMMENDED TORQUE SETTINGS

Below are recommended rotor bolt torque settings. For more information and 'How to Video's' please visit www.clarks.bike

Fitting Position	Fitting Size	Torque Setting
Rotor bolt	Torx T25	6.2 NM



DIRT DISSIPATION



HEAT DISSIPATION



LIGHTWEIGHT



PRECISION ENGINEERED

- Calliper brackets 36-39
- V-Brakes 40-43
- Brake pads & cartridges 44-49
- Cable kits & wires 50-57
- Cassettes 59



- Chains & accessories 60-61
- Chainrings 62-63
- Bottom brackets 64
- Gears 65
- Grips 66-75
- E-Bike 76-77
- Headsets 78-79
- Hydraulics 80-87
- Service - trays 88-89
- Service - Wire, cable & hose 90-91
- Service - Parts 92-94
- Bottle Cages 95

ROTORS ■ FLOATING

Clarks range of floating rotors feature carriers manufactured from aerospace grade materials, combined with stainless steel braking bands. Due to the two piece design of the rotor, this drastically reduces the amount of heat transfer, making the floating rotors less vulnerable to warping and provides the rider with consistent performance.

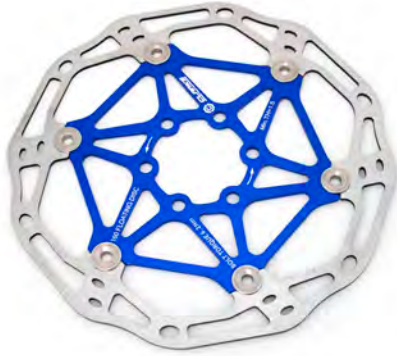

CFR-02

- Lightweight high performance floating rotor
- 7075 Grade alloy carrier and steel braking band

Options

Sizes - 160mm (109g), 180mm (119g) 203mm (133g)

Colours - Red, Blue, Orange, White, Pink, Green, Purple, Black, Gold.

Part Numbers

Colour	160mm	180mm	203mm
Red	CFR-02-160-RED	CFR-02-180-RED	CFR-02-203-RED
Blue	CFR-02-160-BLUE	CFR-02-180-BLUE	CFR-02-203-BLUE
Orange	CFR-02-160-ORANGE	CFR-02-180-ORANGE	CFR-02-203-ORANGE
White	CFR-02-160-WHITE	CFR-02-180-WHITE	CFR-02-203-WHITE
Pink	CFR-02-160-PINK	CFR-02-180-PINK	CFR-02-203-PINK
Green	CFR-02-160-GREEN	CFR-02-180-GREEN	CFR-02-203-GREEN
Purple	CFR-02-160-PURPLE	CFR-02-180-PURPLE	CFR-02-203-PURPLE
Black	CFR-02-160-BLACK	CFR-02-180-BLACK	CFR-02-203-BLACK
Gold	CFR-02-160-GOLD	CFR-02-180-GOLD	CFR-02-203-GOLD



CFR-06

- Carrier constructed of Alloy 7075 aerospace grade
- Stainless steel braking band
- Invulnerable to warp

Options

Sizes - 160mm (104g), 180mm (118g) 203mm (123g)

Colours - Red, Blue, Orange, White, Pink, Green, Purple, Black or Gold.

Part Numbers

Colour	160mm	180mm	203mm
Red	CFR-06-160-RED	CFR-06-180-RED	CFR-06-203-RED
Blue	CFR-06-160-BLUE	CFR-06-180-BLUE	CFR-06-203-BLUE
Orange	CFR-06-160-ORANGE	CFR-06-180-ORANGE	CFR-06-203-ORANGE
White	CFR-06-160-WHITE	CFR-06-180-WHITE	CFR-06-203-WHITE
Pink	CFR-06-160-PINK	CFR-06-180-PINK	CFR-06-203-PINK
Green	CFR-06-160-GREEN	CFR-06-180-GREEN	CFR-06-203-GREEN
Purple	CFR-06-160-PURPLE	CFR-06-180-PURPLE	CFR-06-203-PURPLE
Black	CFR-06-160-BLACK	CFR-06-180-BLACK	CFR-06-203-BLACK
Gold	CFR-06-160-GOLD	CFR-06-180-GOLD	CFR-06-203-GOLD



CFR-13FA

An up to date design of the floating rotor, this rotor offers superior rigidity and is also very light in its construction.

- Very high grade 7075 alloy carrier that offers superb strength
- Stainless steel heat resistant braking band
- Chamfered edge to prevent rider injury
- Built in wear indicator

Options

Sizes - 140mm (95g), 160mm (100g), 180mm (120g) 203mm (140g)

Colours - Black

Part Numbers

Colour	140mm	160mm	180mm	203mm
Black	CFR-13FA-140	CFR-13FA-160	CFR-13FA-180	CFR-13FA-203



AR-18

Clarks lightweight floating rotor provides superb braking characteristics regardless of conditions.

- 7075 Grade alloy carrier offers superb heat resistant characteristics reducing the chances of rotor warp during prolonged braking.
- 420CR Steel braking band offers a superb quality surface to get the very best brake performance from your system regardless of conditions.

Options

Sizes - 140mm (86g), 160mm (108g), 180mm (135g) or 203mm (158g)

Colours - Black

Part Numbers

Part Number	Description	Part Number	Description
CFR-AR-18-140-BLK-AM	140mm	CFR-AR-18-180-BLK-AM	180mm
CFR-AR-18-160-BLK-AM	160mm	CFR-AR-18-203-BLK-AM	203mm

- Hydraulic disc brakes 4-17
- Mechanical disc brakes 18-23
- Disc pads 24-29
- Rotors 30-35**
- Calliper brackets 36-39
- V-Brakes 40-43
- Brake pads & cartridges 44-49
- Cable kits & wires 50-57
- Cassettes 59
- Chains & accessories 60-61
- Chainrings 62-63
- Bottom brackets 64
- Gears 65
- Grips 66-75
- E-Bike 76-77
- Headsets 78-79
- Hydraulics 80-87
- Service - trays 88-89
- Service - Wire, cable & hose 90-91
- Service - Parts 92-94
- Bottle Cages 95

ROTORS ■ FLOATING

Clarks range of floating rotors feature carriers manufactured from aerospace grade materials, combined with stainless steel braking bands. Due to the two piece design of the rotor, this drastically reduces the amount of heat transfer, making the floating rotors less vulnerable to warping and provides the rider with consistent performance.

AR-10

- 7075 Grade alloy carrier offers superb heat resistant characteristics reducing the chances of rotor warp during prolonged braking.
- Wide, drilled 420CR Steel braking band offers a superb quality surface making sure of good disc pad contact, ensuring best brake performance through all riding conditions.

Options

Sizes - 160mm (126g), 180mm (148g), or 203mm (172g)

Colours - Black, Red or Blue

Part Numbers

Part Number	Description	Colour
CFR-AR-10-160-BLK-AM	160mm	Black
CFR-AR-10-180-BLK-AM	180mm	Black
CFR-AR-10-203-BLK-AM	203mm	Black
CFR-AR-10-160-RED-AM	160mm	Red
CFR-AR-10-180-RED-AM	180mm	Red
CFR-AR-10-203-RED-AM	203mm	Red
CFR-AR-10-160-BLUE-AM	160mm	Blue
CFR-AR-10-180-BLUE-AM	180mm	Blue
CFR-AR-10-203-BLUE-AM	203mm	Blue



AR-19

- 7075 Grade alloy carrier offers superb heat resistant characteristics reducing the chances of rotor warp during prolonged braking.
- Rigid 420CR Steel braking band, strengthened across the carrier joints, provides a superb quality surface combined with additional strength to help prevent rotor warp under extreme braking conditions.

Options

Sizes - 160mm (112g), 180mm (134g), or 203mm (158g)

Colours - Black, Red or Blue

Part Numbers

Part Number	Description	Colour
CFR-AR-19-160-BLK-AM	160mm	Black
CFR-AR-19-180-BLK-AM	180mm	Black
CFR-AR-19-203-BLK-AM	203mm	Black
CFR-AR-19-160-RED-AM	160mm	Red
CFR-AR-19-180-RED-AM	180mm	Red
CFR-AR-19-203-RED-AM	203mm	Red
CFR-AR-19-160-BLUE-AM	160mm	Blue
CFR-AR-19-180-BLUE-AM	180mm	Blue
CFR-AR-19-203-BLUE-AM	203mm	Blue



AR-21

- Anodised 7075 Grade alloy carrier offers superb heat resistant characteristics reducing the chances of rotor warp during prolonged braking.
- 420CR Steel braking band offers a superb quality surface to get the very best brake performance from your system regardless of conditions.

Options

Sizes - 160mm (98g), 180mm (120g), 203mm (144g)

Colours - Black, Red or Blue

Part Numbers

Part Number	Description	Colour
CFR-AR-21-160-BLK-AM	160mm	Black
CFR-AR-21-180-BLK-AM	180mm	Black
CFR-AR-21-203-BLK-AM	203mm	Black
CFR-AR-21-160-RED-AM	160mm	Red
CFR-AR-21-180-RED-AM	180mm	Red
CFR-AR-21-203-RED-AM	203mm	Red
CFR-AR-21-160-BLUE-AM	1460mm	Blue
CFR-AR-21-180-BLUE-AM	180mm	Blue
CFR-AR-21-203-BLUE-AM	203mm	Blue



Hydraulic disc brakes
4-17

Mechanical disc brakes
18-23

Disc pads
24-29

Rotors
30-35

Calliper brackets
36-39

V-Brakes
40-43

Brake pads & cartridges
44-49

Cable kits & wires
50-57

Cassettes
59

Chains & accessories
60-61

Chainrings
62-63

Bottom brackets
64

Gears
65

Grips
66-75

E-Bike
76-77

Headsets
78-79

Hydraulics
80-87

Service - trays
88-89

Service - Wire, cable & hose
90-91

Service - Parts
92-94

Bottle Cages
95

ROTORS ■ CENTRE LOCK

Clarks centre lock rotor feature a high grade stainless steel rotors with aluminium splined centre lock fitting. Shimano compatible our rotors offer reduced heat transfer, lower noise and consistent braking. Supplied with optional replacement locking rings.

LR

- High grade stainless steel rotor
- Shimano compatible
- Supplied with locking rings for Quick release and Thru axle hub
- Consistent braking

Options

Sizes - 160mm (168g), 180mm (188g), or 203mm (216g)

Part Numbers

Part Number	Description
C-CL-160-1-LR-QRTA-V1V2-AM	160mm
C-CL-180-1-LR-QRTA-V1V2-AM	180mm
C-CL-203-1-LR-QRTA-V1V2-AM	203mm



Thru Axle locking ring



Quick Release locking ring

A1

- Lightweight
- High grade stainless steel rotor
- Shimano compatible
- Supplied with locking ring Thru axle hub
- Consistent braking

Options

Sizes - 140mm (120g), 160mm (136g), 180mm (158g), or 203mm (178g)

Part Numbers

Part Number	Description
C-CL-A1-140-BC	140mm
C-CL-A1-160-BC	160mm
C-CL-A1-180-BC	180mm
C-CL-A1-203-BC	203mm



Thru Axle locking ring

ROTORS ■ SINGLE PIECE

Clarks centre lock rotor feature a high grade stainless steel rotors with aluminium splined centre lock fitting. Shimano compatible our rotors offer reduced heat transfer, lower noise and consistent braking. Supplied with optional replacement locking rings.



A001

Designed for the additional braking forces of e-bikes, this rotor features a rigid design and is manufactured from 2.25mm gauge steel

- 2.25mm Gauge Steel Rotor
- Rigid design manufactured from 420CR Steel

Options

Sizes - 203mm (200g)

Colours - Silver

Part Numbers

Part Number	Description
CL-A001-20-SILVER-AM	203mm

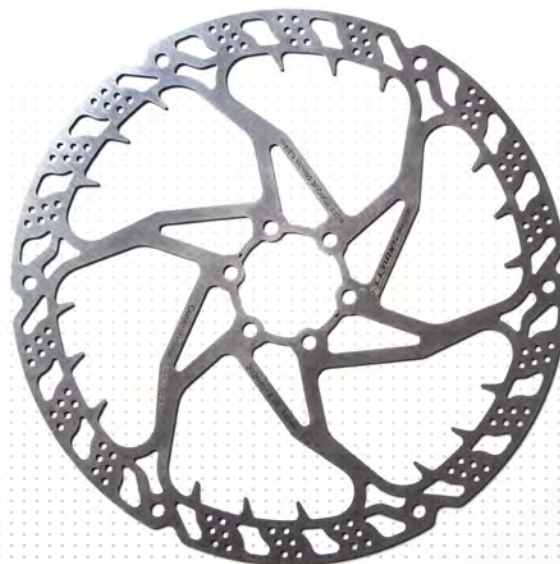

- Hydraulic disc brakes 4-17
- Mechanical disc brakes 18-23
- Disc pads 24-29
- Rotors 30-35
- Calliper brackets 36-39
- V-Brakes 40-43
- Brake pads & cartridges 44-49
- Cable kits & wires 50-57
- Cassettes 59
- Chains & accessories 60-61
- Chainrings 62-63
- Bottom brackets 64
- Gears 65
- Grips 66-75
- E-Bike 76-77
- Headsets 78-79
- Hydraulics 80-87
- Service - trays 88-89
- Service - Wire, cable & hose 90-91
- Service - Parts 92-94
- Bottle Cages 95

ROTORS ■ SINGLE PIECE



CL

- Single piece Stainless Steel rotor
- Available in Stainless Steel or with ED black finish

Options

Sizes - 140mm (87g) 160mm (106g) or 180mm (121g)

Colours - Plain or Black

Part Numbers

Colour	140mm	160mm	180mm
Plain	CL-140	CL-160	CL-180
Black	-	CL-160-BLACK	CL-180-BLACK



TL-027

- Single piece Stainless Steel rotor
- Specifically designed to withstand the greater forces required for e-bikes

Options

Sizes - 140mm (114g), 160mm (138g), 180mm (162g) or 203mm (216g)

Colours - Plain

Part Numbers

Colour	140mm	160mm	180mm	203mm
Plain	TL-027-140	TL-027-160	TL-027-180	TL-027-203



CD-06

- Single piece rotor with wavy braking band
- Available with coloured centre.

Options

Sizes - 160mm (94g) or 180mm (110g)

Colours - Black, Red, White or Blue

Part Numbers

Colour	160mm	180mm
Black	CD-06-160-BLACK	CD-06-180-BLACK
Red	CD-06-160-RED	CD-06-180-RED
White	CD-06-160-WHITE	CD-06-180-WHITE
Blue	CD-06-160-BLUE	CD-06-180-BLUE



Z8

- Single piece Stainless Steel rotor
- Lightweight design

Options

Sizes - 160mm (108g), 160mm (148g), 203mm (194g)

Colours - Silver

Part Numbers

Part Number	Description
CL-Z8-160-SILVER-AM	140mm
CL-Z8-180-SILVER-AM	160mm
CL-Z8-1203-SILVER-AM	203mm

Hydraulic disc brakes
4-17

Mechanical disc brakes
18-23

Disc pads
24-29

Rotors
30-35

Calliper brackets
36-39

V-Brakes
40-43

Brake pads & cartridges
44-49

Cable kits & wires
50-57

Cassettes
59

Chains & accessories
60-61

Chainrings
62-63

Bottom brackets
64

Gears
65

Grips
66-75

E-Bike
76-77

Headsets
78-79

Hydraulics
80-87

Service - trays
88-89

Service - Wire, cable & hose
90-91

Service - Parts
92-94

Bottle Cages
95



CALLIPER BRACKETS

A complete range of Disc brake Calliper brackets available in all sizes, 160mm, 180mm, 203mm, for both Post Mount and International Standard fitting, all supplied with washers as standard. From CNC machined lightweight brackets, through to anodised (in an array of colours) Clarks has a bracket to match any system.



SERVICE & REPAIR PARTS

clarks.bike/order-spare-parts.html



SERVICE & FITTING VIDEOS

clarks.bike/how-to-videos.html



PRODUCT HELPLINE
info@clarks.bike

+44 (0)1455 254800



- Hydraulic disc brakes 4-17
- Mechanical disc brakes 18-23
- Disc pads 24-29
- Rotors 30-35

CALLIPER BRACKET STANDARDS

3 Standards | I.S. | P.M. | F.M.

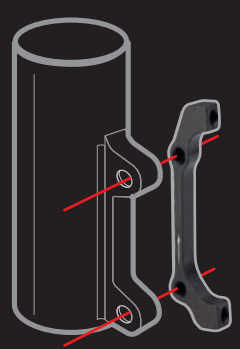

International Standard [I.S.]

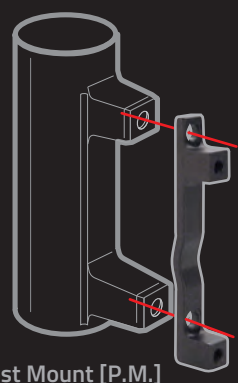

Post Mount [P.M.]

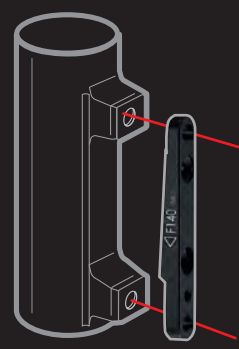

Flat Mount [F.M.]

- Calliper brackets 36-39

- V-Brakes 40-43

- Brake pads & cartridges 44-49

- Cable kits & wires 50-57

- Cassettes 59

- Chains & accessories 60-61



PRECISION ENGINEERED



LIGHTWEIGHT



ALLOY



- Chainrings 62-63

- Bottom brackets 64

- Gears 65

- Grips 66-75

- E-Bike 76-77

- Headsets 78-79

- Hydraulics 80-87

- Service - trays 88-89

- Service - Wire, cable & hose 90-91

- Service - Parts 92-94

- Bottle Cages 95

CLARKS

CALLIPER BRACKETS

(FIS - Front International Standard | RIS - Rear International Standard | FPM - Front Post Mount | FM - Flat Mount)



Flat Mount Brackets

Flat mount is a fitting standard allowing for more space efficient callipers to be fitted to bikes. It allows a direct fitted calliper to use a 140mm rotor as standard. All our Flat Mount brackets meet standard requirements and have been precisely manufactured to ensure a perfect fit. All available in black.

Options

Sizes - 140mm, 160mm or 180mm



Part Numbers

Fitting	Size	Black
Front Flat Mount to Post Mount	140	CB-FMPM-F140
Front Flat Mount to Post Mount	160	CB-FMPM-F160
Rear Flat Mount to Post Mount	140	CB-FMPM-R140
Rear Flat Mount to Post Mount	160	CB-FMPM-R160
Rear Flat Mount to Flat Mount	160	CB-FMFM-R160
Front Flat Mount to Flat Mount	140/160	CB-FMFM-F140/160
Rear Post Mount to Flat Mount	180	CB-PMFM-R180
Rear Flat Mount to Flat Mount	180	CB-FMFM-R180
Front Flat Mount to Flat Mount	180	CB-FMFM-F180
Front Post Mount to Flat Mount	180	CB-PMFM-F180



Flat Mount Bolts

All of the following bolts are made from steel then coated in DACROMET® to prevent corrosion, they can be used to secure Flat Mount brackets.

Options

Sizes - 12mm, 23mm, 28mm, 33mm, 38mm, 43mm or 48mm



Part Numbers

Fitting	Size	Black
2 x Flat Mount Bolts	12mm	CMB-FM07
2 x Flat Mount Bolts	23mm	CMB-FM01
2 x Flat Mount Bolts	28mm	CMB-FM02
2 x Flat Mount Bolts	33mm	CMB-FM03
2 x Flat Mount Bolts	38mm	CMB-FM04
2 x Flat Mount Bolts	43mm	CMB-FM05
2 x Flat Mount Bolts	48mm	CMB-FM06



- Hydraulic disc brakes 4-17
- Mechanical disc brakes 18-23
- Disc pads 24-29
- Rotors 30-35
- Calliper brackets 36-39
- V-Brakes 40-43
- Brake pads & cartridges 44-49
- Cable kits & wires 50-57
- Cassettes 59
- Chains & accessories 60-61
- Chainrings 62-63
- Bottom brackets 64
- Gears 65
- Grips 66-75
- E-Bike 76-77
- Headsets 78-79
- Hydraulics 80-87
- Service - trays 88-89
- Service - Wire, cable & hose 90-91
- Service - Parts 92-94
- Bottle Cages 95

CALLIPER BRACKETS

(FIS - Front International Standard | RIS - Rear International Standard | FPM - Front Post Mount | FM - Flat Mount)

Anodised Brackets

Aluminium anodised brackets in a range of colours and sizes to suit any style of bike and fit any brake system.

Options

Sizes - 160mm, 180mm or 203mm

Colours - Orange, Red or Blue

Taiwan

Part Numbers

Colour	Fitting	Size	Part No.
Orange	Front International Standard	160	CB-6065ANO-160FIS-ORANGE
Orange	Rear International Standard	160	CB-6065ANO-160RIS-ORANGE
Orange	Front International Standard	180	CB-6065ANO-180FIS-ORANGE
Orange	Rear International Standard	180	CB-6065ANO-180RIS-ORANGE
Orange	Rear International Standard	203	CB-6065ANO-203RIS-ORANGE
Orange	Front Post Mount	180	CB-6065ANO-180FPM-ORANGE
Orange	Front Post Mount	203	CB-6065ANO-203FPM-ORANGE
Red	Front International Standard	160	CB-6065ANO-160FIS-RED
Red	Rear International Standard	160	CB-6065ANO-160RIS-RED
Red	Front International Standard	180	CB-6065ANO-180FIS-RED
Red	Rear International Standard	180	CB-6065ANO-180RIS-RED
Red	Rear International Standard	203	CB-6065ANO-203RIS-RED
Red	Front Post Mount	180	CB-6065ANO-180FPM-RED
Red	Front Post Mount	203	CB-6065ANO-203FPM-RED
Blue	Front International Standard	160	CB-6065ANO-160FIS-BLUE
Blue	Rear International Standard	160	CB-6065ANO-160RIS-BLUE
Blue	Front International Standard	180	CB-6065ANO-180FIS-BLUE
Blue	Rear International Standard	180	CB-6065ANO-180RIS-BLUE
Blue	Rear International Standard	203	CB-6065ANO-203RIS-BLUE
Blue	Front Post Mount	180	CB-6065ANO-180FPM-BLUE
Blue	Front Post Mount	203	CB-6065ANO-203FPM-BLUE



Standard Brackets

Our standard range of aluminium brackets for Post Mount and International Standard mountings, all available in black.

Options

Sizes - 140mm, 160mm, 180mm or 203mm

Part Numbers

Fitting	Size	Black
Front International Standard	180	CB-F180IS
Rear International Standard	160	CB-R160IS
Front International Standard	160	CB-F160IS
Rear International Standard	140	CB-R140IS
Front International Standard	203	CB-F203IS
Rear international Standard	180	CB-R180IS
Front Post Mount	180	CB-F180PM
Front Post Mount (A11)	180	CB-F180PM-A-11
Rear Post Mount (A11)	180	CB-R180PM-A-11
Front Post Mount (A10)	160-203	CB-F203PM-A-10
Rear Post Mount (A10)	160-203	CB-R203PM-A-10
Front Post Mount (A12)	180-203	CB-F203PM-A-12
Rear Post Mount (A12)	180-203	CB-R203PM-A-12
Front Post Mount (A13)	160-203	CB-F203PM-A-13
Rear Post Mount (A13)	160-203	CB-R203PM-A-13



Hydraulic disc brakes
4-17

Mechanical disc brakes
18-23

Disc pads
24-29

Rotors
30-35

Calliper brackets
36-39

V-Brakes
40-43

Brake pads & cartridges
44-49

Cable kits & wires
50-57

Cassettes
59

Chains & accessories
60-61

Chainrings
62-63

Bottom brackets
64

Gears
65

Grips
66-75

E-Bike
76-77

Headsets
78-79

Hydraulics
80-87

Service - trays
88-89

Service - Wire, cable & hose
90-91

Service - Parts
92-94

Bottle Cages
95



CLARKS
EXCEED YOUR LIMITATIONS



V-BRAKES

Clarks V-brakes are designed to offer controlled braking in all environments. Engineered from aluminium to reduce weight and provide resistance to rust and weathering, Clarks V-Brake systems are simple to fit and maintain. All Clarks V-brake levers are 2 to 3 fingers reach providing the rider with more control at the handlebars.



**SERVICE &
REPAIR PARTS**

clarks.bike/order-spare-parts.html



**SERVICE &
FITTING VIDEOS**

clarks.bike/how-to-videos.html



PRODUCT HELPLINE
info@clarks.bike

+44 (0)1455 254800

ADVANTAGES OF V-BRAKES

Greater mechanical advantage
Simple to fit and maintain
Lightweight alloy
Controlled, smooth braking
Very effective in all weather conditions



ALLOY



ALL WEATHER



EASY FIT

Hydraulic disc brakes
4-17

Mechanical disc brakes
18-23

Disc pads
24-29

Rotors
30-35

Calliper brackets
36-39

V-Brakes
40-43

Brake pads & cartridges
44-49

Cable kits & wires
50-57

Cassettes
59

Chains & accessories
60-61

Chainrings
62-63

Bottom brackets
64

Gears
65

Grips
66-75

E-Bike
76-77

Headsets
78-79

Hydraulics
80-87

Service - trays
88-89

Service - Wire, cable & hose
90-91

Service - Parts
92-94

Bottle Cages
95

V-BRAKE ■ SETS & CALLIPER SETS

V-Brake Set

V-brake calliper and lever set including all cable housing, fixings and stainless steel guide pipes. Ideal for MTB and Hybrid cycles. Supplied with pads.

- Compatible with both U & V-Brake callipers
- Flip flop design
- Hinged clamp for easy installation
- Integrated cable adjusters
- Die cast alloy construction linear pull brake
- 55mm rubber brakes shoes Inc.
- Steel guide pipe and rubber boot Inc.
- Supplied with front and rear cables
- Supplied with outer casing

Contents:

Front and rear set - 2 x callipers, 2 x levers, cables, pads and stainless steel guide pipes.

Colours: Black or Silver

Part Numbers:	Description:
CLK-115-27-SILVER	V-Brake calliper and lever set (Silver)
CLK-115-27-BLACK	V-Brake calliper and lever set (Black)

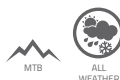

V-Brake Set

V-brake calliper and lever set including all cable housing, fixings and stainless steel guide pipes. Ideal for MTB and Hybrid cycles. Supplied with pads.

- Compatible with both U & V-Brake callipers
- Flip flop design
- Hinged clamp for easy installation
- Integrated cable adjusters
- Die cast alloy construction linear pull brake
- 55mm rubber brakes shoes Inc.
- Steel guide pipe and rubber boot Inc.
- Supplied with front and rear cables
- Supplied with outer casing

Contents:

Front and rear set - 2 x callipers, 2 x levers, cables, pads and stainless steel guide pipes.

Colour: Black

Part Numbers:	Description:
CLK-370-960	V-Brake calliper and lever set



V-Brake Callipers

Steel callipers, ideal for MTB and Hybrid cycles. Supplied with pads.

- Steel construction linear pull brake
- 55mm rubber brakes shoes Included
- Steel guide pipe and rubber boot Included

Contents:

Front and rear calliper - 2 x callipers, 2 x pairs of pads, guide pipe and boots

Colour: Black

Part Numbers:	Description:
CLK115X2	Front & Rear calliper set



Hydraulic disc brakes 4-17

Mechanical disc brakes 18-23

Disc pads 24-29

Rotors 30-35

Calliper brackets 36-39

V-Brakes 40-43

Brake pads & cartridges 44-49

Cable kits & wires 50-57

Cassettes 59

Chains & accessories 60-61

Chainrings 62-63

Bottom brackets 64

Gears 65

Grips 66-75

E-Bike 76-77

Headsets 78-79

Hydraulics 80-87

Service - trays 88-89

Service - Wire, cable & hose 90-91

Service - Parts 92-94

Bottle Cages 95

V-BRAKE ■ CALLIPERS & LEVERS

V-Brake Calliper

Die cast alloy calliper, ideal for MTB and Hybrid cycles. Supplied with pads.

- Die cast alloy construction
- Linear pull brake
- 55mm rubber brakes shoes Inc.
- Steel guide pipe and rubber boot Inc

Contents:

Front or rear calliper - 1 x Calliper, 1 x pair of pads, guide pipe and boot

Colour: Black

Part Numbers:	Description:
CLK-960DX	Calliper



V-Brake Levers

Die cast alloy bracket and lever, for use with twist and thumb gear shift.

- Die cast alloy construction
- Compatible with both U & V brake callipers
- Flip flop design
- Hinged clamp for easy installation
- Integrated cable adjusters

Colour: Black

Part Numbers:	Description:
CLK-370D	Front and rear levers



V-Brake Levers

Die cast alloy bracket and lever, for use with twist and thumb gear shift.

- Die cast alloy construction
- Compatible with both U & V-Brake callipers
- Flip flop design
- Hinged clamp for easy installation
- Integrated cable adjusters

Colour: Black

Part Numbers:	Description:
CLK-2B	Front and rear levers



V-Brake Levers

Die cast alloy bracket and lever, for use with twist and thumb gear shift.

- Die cast alloy construction
- Compatible with both U & V-Brake callipers
- Flip flop design
- Hinged clamp for easy installation
- Integrated cable adjusters

Colours: Black, or White

Part Numbers:	Description:
CLK-2B11	Front and rear levers (Black)
CLK-2B11W	Front and rear levers (White)



Hydraulic disc brakes
4-17

Mechanical disc brakes
18-23

Disc pads
24-29

Rotors
30-35

Calliper brackets
36-39

V-Brakes
40-43

Brake pads & cartridges
44-49

Cable kits & wires
50-57

Cassettes
59

Chains & accessories
60-61

Chainrings
62-63

Bottom brackets
64

Gears
65

Grips
66-75

E-Bike
76-77

Headsets
78-79

Hydraulics
80-87

Service - trays
88-89

Service - Wire, cable & hose
90-91

Service - Parts
92-94

Bottle Cages
95



CLARKS
EXCEED YOUR LIMITATIONS

BRAKE PADS & CARTRIDGES

Clarks comprehensive range of rubber brake pads suits all riding styles. MTB, Road or BMX. Our pads are compatible with all major braking systems and rim materials. Elite pads use compounds that give unrivalled low and high speed braking performance. Our standard range of pads offer reliable and consistent braking. Replacement cartridges provide the rider with a choice of compounds for various riding conditions.



V-TYPE



DIRT DISSIPATION



ALL WEATHER



CARBON RIMS



SERVICE & REPAIR PARTS

clarks.bike/order-spare-parts.html



SERVICE & FITTING VIDEOS

clarks.bike/how-to-videos.html



PRODUCT HELPLINE
info@clarks.bike

+44 (0)1455 254800

BRAKE PADS & CARTRIDGES ■ ROAD ELITE

Our top performance Elite range of pads are specifically designed for road bicycles. These components feature carriers manufactured from lightweight materials and precision CNC engineered, combined with non-abrasive brake compounds that will perform in all conditions and on all performance engineered braking surfaces without creating any damage.



CPS220

- 50mm Brake pad.
- Triple compound pad for all weather conditions.
- Unique design to reduce noise and increase performance.

Part Number: CPS220



CPS240

- Top performance on dry & wet rims.
- Polycarbonate cut away carrier for weight reduction.
- Unique pad design for improved noise reduction and better performance.
- Interchangeable cartridge.
- Extra set of brake cartridges included.

Part Number: CPS240



CPS240B

- Top performance on dry & wet rims.
- Polycarbonate cut away carrier for weight reduction.
- Unique pad design for improved noise reduction and better performance.
- Interchangeable cartridge
- Extra set of brake cartridges included.

Part Number: CPS240B



CPS250

- Angle adjustment fitting.
- Large wing design for efficient water dissipation.
- Top performance on dry & wet rims.
- Available in pairs and bulk bags of 25 pairs

Part Number: CPS250, CPS250-BULK



CPS305B

- Top performance on dry & wet rims
- Lightweight alloy carrier
- Unique pad design for improved noise reduction and better performance.
- Interchangeable cartridge.

Part Number: CPS305B



CPS459

- Top performance on dry rims.
- High performance rubber compound.
- Interchangeable cartridge.

Part Number: CPS459



CPS461

- Top performance on dry rims.
- CNC Machined wing for weight reduction.
- Interchangeable cartridge.
- High performance rubber compound.

Part Number: CPS461



CPS471 RED

- Top performance on dry & wet rims.
- Lightweight CNC Machined Alloy carrier.
- Interchangeable cartridges.

Part Number: CPS471



CPS472C

- Top performance on dry & wet rims.
- CNC Machined wing for weight reduction.
- Unique pad design for improved noise reduction and better performance.

Part Number: CPS472C

Hydraulic disc brakes
4-17

Mechanical disc brakes
18-23

Disc pads
24-29

Rotors
30-35

Calliper brackets
36-39

V-Brakes
40-43

Brake pads & cartridges
44-49

Cable kits & wires
50-57

Cassettes
59

Chains & accessories
60-61

Chainrings
62-63

Bottom brackets
64

Gears
65

Grips
66-75

E-Bike
76-77

Headsets
78-79

Hydraulics
80-87

Service - trays
88-89

Service - Wire, cable & hose
90-91

Service - Parts
92-94

Bottle Cages
95

BRAKE PADS & CARTRIDGES ■ ROAD CARBON RIM SPECIFIC

Clarks carbon specific compounds have been manufactured using the best material composites and manufacturing methods available today. The end result is a range of brake pads and cartridges with compounds that offer low noise, low abrasion, superb modulation and stopping power that is comparable to alloy rim braking.

- Hydraulic disc brakes 4-17
- Mechanical disc brakes 18-23
- Disc pads 24-29
- Rotors 30-35
- Calliper brackets 36-39
- V-Brakes 40-43
- Brake pads & cartridges 44-49
- Cable kits & wires 50-57
- Cassettes 59
- Chains & accessories 60-61
- Chainrings 62-63
- Bottom brackets 64
- Gears 65
- Grips 66-75
- E-Bike 76-77
- Headsets 78-79
- Hydraulics 80-87
- Service - trays 88-89
- Service - Wire, cable & hose 90-91
- Service - Parts 92-94
- Bottle Cages 95



CPS200CARB

- Specific compound for Carbon rims.
- 50mm brake pad.

Icons: Carbon Rims, Replacement Cartridge, Dirt Dissipation

Part Number: CPS200CARB



CPS305/CARB

- Top performance on dry & wet rims.
- Lightweight carbon carrier.
- Unique carbon rim specific compound for exceptional performance.
- Interchangeable cartridge.

Icons: Carbon Rims, Replacement Cartridge, Lightweight, Dirt Dissipation

Part Number: CPS305/CARB



CPS453-CARB

- Shimano compatible.
- Carbon specific road brake pad.
- Lightweight alloy carrier.
- Interchangeable cartridge.

Icons: Replacement Cartridge, Lightweight, Dirt Dissipation

Part Number: CPS453/CARB



CPS453-CARB-INS

- Carbon specific road brake cartridge.
- Shimano compatible.
- For CPS453-CARB & CPS473-CARB.

Icons: Replacement Cartridge, Lightweight, Dirt Dissipation

Part Number: CPS453/CARB-INS



CPS460-CARB

- Campagnolo compatible.
- Carbon specific road brake pad.
- Lightweight alloy carrier.
- Interchangeable cartridge.

Icons: Replacement Cartridge, Lightweight, Dirt Dissipation

Part Number: CPS460/CARB



CPS473-CARB

- Shimano compatible.
- Carbon specific road brake pad.
- Lightweight alloy carrier.
- Interchangeable cartridge.

Icons: Replacement Cartridge, Lightweight, Dirt Dissipation

Part Number: CPS473/CARB



CPS474-CARB

- Campagnolo compatible.
- Carbon specific road brake pad.
- Lightweight alloy carrier.
- Interchangeable cartridge.

Icons: All Weather, Replacement Cartridge, Dirt Dissipation

Part Number: CPS474/CARB



CPS474-CARB-INS

- Carbon specific road brake cartridge.
- Campagnolo compatible.
- For CPS474-CARB & CPS460-CARB

Icons: Replacement Cartridge, Lightweight, All Weather

Part Number: CPS474/CARB-INS

BRAKE PADS & CARTRIDGES ■ BMX



CP600

- Threaded post pad for BMX linear pull brakes

Icons: V-TYPE, Replacement Cartridge, Dirt Dissipation

Part Number: CP600



CP960-VCR-Z-02

- 72mm brake cartridge
- Threaded posts
- Insert for BMX carbon rims

Icons: Replacement Cartridge, V-TYPE, Dirt Dissipation

Part Number: CP960-VCR-Z-02



CP960-VCR

- 72mm replacement insert
- For BMX carbon rims

Icons: Replacement Cartridge, Dirt Dissipation

Part Number: CP960-VCR

BRAKE PADS & CARTRIDGES ■ ROAD

Our range of road brake pads feature carrier designs that are compatible with all current brake systems as well as some of the older manufacturers that are less common in the current marketplace. All pads use non-abrasive compounds that will not damage wheel rims, as well as specialist compounds for performance braking surfaces such as carbon rims.



CP100

- Weinmann & Raleigh compatible.
- 40mm X pattern blocks.
- Available in dispenser box (10 pairs).

Part Numbers: CP100, CP100-10-DB



CP200

- 54mm replacement brake cartridges.
- Complete absence of abrasive materials which damage rims.
- Available in 4's.

Part Number: CP200, CP200X4



CP220

- 52mm replacement brake cartridge.
- Complete absence of abrasive materials which damage rims.

Part Number: CP220



CP230

- 52mm replacement brake cartridge.
- Complete absence of abrasive materials which damage rims.

Part Number: CP230



CP240

- Campagnolo compatible
- 50mm brake shoe and cartridge
- Interchangeable cartridge
- Extra pads included

Part Number: CP240



CP250

- Campagnolo compatible
- 50mm integral brake block, integral calliper.

Part Number: CP250



CP300

- Weinmann & Raleigh compatible
- 35mm stud pattern blocks

Part Number: CP300



CP302

- Weinmann & Raleigh compatible.
- Standard stirrup brake-flat top.

Part Number: CP302



CP305

- Campagnolo compatible.
- Top performance on dry & wet rims.
- Interchangeable cartridge.

Part Number: CP305



CP968

- Suitable for folding bikes.
- 55mm pad.
- Reinforced internal frame and unique compound to increase stopping power and reduced wear time.

Part Number: CP968



CPE01-E (E-Bike Brake Pad)

- 75mm E-bike specific brake pad
- Reinforced internal frame and unique compound to increase stopping power and reduced wear time.

Part Number: CPE01-E



CPE02-E (E-Bike Brake Pad)

- 80mm E-bike specific brake pad
- Reinforced internal frame and unique compound to increase stopping power and reduced wear time

Part Number: CPE02-E

Hydraulic disc brakes
4-17

Mechanical disc brakes
18-23

Disc pads
24-29

Rotors
30-35

Calliper brackets
36-39

V-Brakes
40-43

Brake pads & cartridges
44-49

Cable kits & wires
50-57

Cassettes
59

Chains & accessories
60-61

Chainrings
62-63

Bottom brackets
64

Gears
65

Grips
66-75

E-Bike
76-77

Headsets
78-79

Hydraulics
80-87

Service - trays
88-89

Service - Wire, cable & hose
90-91

Service - Parts
92-94

Bottle Cages
95

BRAKE PADS & CARTRIDGES ■ MTB/HYBRID ELITE

Specifically designed for purpose, the Clarks range of Elite MTB/Hybrid pads and cartridges will 'wipe' dirt from the rim whilst delivering top performance braking power and consistency. Using CNC machined carriers combined with lightweight materials our brake pads will complement all of the top manufacturers braking systems whilst providing great stopping power.



- CPS301**
- Triple contour design 72mm brake pad
 - For linear pull brakes with threaded posts
 - Top performance on dry & wet rims

Part Number: CPS301



- CP310**
- Magura hydraulic rim brakes specific pad
 - 50mm replacement brake cartridge

Part Number: CP310



- CPS310**
- Magura hydraulic rim brakes specific pad
 - Top performance on dry and wet rims

Part Number: CPS310



- CPS501**
- 72mm Replacement brake cartridge
 - Triple contour design 70mm brake pad
 - Unique design to reduce noise and increase performance
 - Available in bike sets (2 pairs)

Part Numbers: CPS501, CPS501X2



- CPS513**
- Triple contour design 72mm brake pad
 - For linear pull brakes with threaded posts
 - Aluminium carrier for weight reduction
 - Interchangeable cartridge
 - Available in bike sets (2 pairs)

Part Numbers: CPS513, CPS513X2



- CPS958**
- Dual contour design 72mm brake pad
 - For linear pull brakes with threaded posts
 - Designed specifically for extreme wet conditions
 - Top performance on dry & wet rims

Part Number: CPS958



- CPS959**
- Dual contour design 72mm brake pad
 - For linear pull brakes with threaded posts
 - Aluminium carrier for weight reduction
 - Top performance on dry & wet rims
 - Interchangeable cartridge

Part Number: CPS959



- CPS959R**
- 72mm Replacement brake cartridge
 - Dual contour design 72mm brake pad
 - Aqua design allowing greater water displacement

Part Number: CPS959R



- CPS960**
- 72mm brake pad
 - Transparent with red inner
 - For linear pull brakes with threaded posts
 - Top performance on dry rims

Part Number: CPS960

- Hydraulic disc brakes 4-17
- Mechanical disc brakes 18-23
- Disc pads 24-29
- Rotors 30-35
- Calliper brackets 36-39
- V-Brakes 40-43
- Brake pads & cartridges 44-49
- Cable kits & wires 50-57
- Cassettes 59
- Chains & accessories 60-61
- Chainrings 62-63
- Bottom brackets 64
- Gears 65
- Grips 66-75
- E-Bike 76-77
- Headsets 78-79
- Hydraulics 80-87
- Service - trays 88-89
- Service - Wire, cable & hose 90-91
- Service - Parts 92-94
- Bottle Cages 95

BRAKE PADS & CARTRIDGES ■ MTB/HYBRID

Clarks range of MTB/Hybrid pads use compounds that will give consistent high performing braking whilst not damaging rims. Brake pads are compatible with all V-Brake/Cantilever brake systems.

Hydraulic disc brakes
4-17

Mechanical disc brakes
18-23

Disc pads
24-29

Rotors
30-35

Calliper brackets
36-39

V-Brakes
40-43

Brake pads & cartridges
44-49

Cable kits & wires
50-57

Cassettes
59

Chains & accessories
60-61

Chainrings
62-63

Bottom brackets
64

Gears
65

Grips
66-75

E-Bike
76-77

Headsets
78-79

Hydraulics
80-87

Service - trays
88-89

Service - Wire, cable & hose
90-91

Service - Parts
92-94

Bottle Cages
95



CP110

- For linear pull brakes with non-threaded posts

Part Number: CP110



CP301

- 60mm MTB, V-type and hybrid brake block
- Threaded post pad for linear pull brakes

Part Number: CP301



CP501

- MTB/V type brake pad
- Threaded post pad for linear pull brakes

Part Number: CP501



CP505/505 BULK

- MTB/V type brake pad
- Available in bulk packs of 25 pairs

Part Numbers: CP505 / CP505BULK



CP510/510 BULK

- 70mm V type cantilever brake block
- Threaded post pad for linear pull brakes
- Available in bulk packs (25 pairs), bike sets (2 pairs)

Part Numbers: CP510 / CP510BULK / CP510X2



CP513

- 72mm Brake pad
- Aluminium carrier for weight reduction
- Extra set of brake cartridges included
- Interchangeable cartridge

Part Number: CP513



CP514

- 55mm V type and cantilever brake block-post type
- For linear pull brakes with non-threaded posts

Part Number: CP514



CP515

- 55mm V type and cantilever brake block
- Threaded post pad for linear pull brakes

Part Number: CP515



CP520/520 BULK

- 70mm V type cantilever brake block
- For linear pull brakes with non-threaded posts
- Available in bulk packs (25 pairs)

Part Numbers: CP520 / CP520BULK



CP522

- 72mm XTR upgrade-post type
- Threaded post pad for linear pull brakes
- Complete with extra free pads

Part Number: CP522

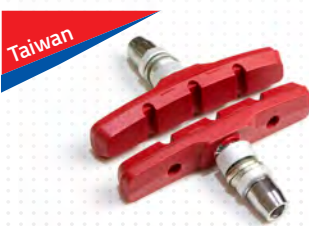

CP511

- 72mm V type cantilever brake block
- Threaded post pad for linear pull brakes
- Red compound brake pads

Part Number: CP511



ALT-02V

- 72mm MTB/V type brake pad
- Aluminium carrier for weight reduction
- Water repellent pad design

Part Number: ALT-02V



CABLE KITS, CABLES & WIRES

Clarks have been manufacturing cables since 1946. Since then improvements in materials and technology have allowed for the development of cables that offer ever smoother and more positive lever feel. Clarks cable range is of a quality second to none, using the latest technologies available to keep your shifting/braking operation as smooth and efficient as possible.



LIGHTWEIGHT



ALLOY



PRECISION ENGINEERED



MAINTENANCE FREE



SERVICE & REPAIR PARTS

clarks.bike/order-spare-parts.html



SERVICE & FITTING VIDEOS

clarks.bike/how-to-videos.html



PRODUCT HELPLINE
info@clarks.bike

+44 (0)1455 254800

CABLE KITS & WIRES ■ CABLE KITS

Designed to deliver durability, weight saving and accuracy – our premium quality, low friction, maintenance free cable kits all contain: 2 x outer casings available in 3 colour options, front and rear pre-lubricated inner wires, frame protectors, ferrules and cable end protectors.

Hybrid Housing Cable Kits

Clarks Hybrid Housing® brake cable kit, sits in the middle ground between SIS housing and conventional spiral housing. Constructed of multiple steel wires running parallel to the housing secured in place by an additional evenly spaced steel spiral of wire, wrapped around the length of the housing. The construction, combined with a PTFE liner results in a superb frictionless operation with a degree of flexibility to make routing around tighter radius more successful. This kit is supplied with a 3000mm length of Hybrid Housing® that is enough to re-fit both front and rear brake lines.



Brake



Brake Kit

Box Contents - Hybrid outer casing, PTFE liner, 2 x PTFE treated brake wires, 6 x CNC Machined ferrules, 2 x Wire end covers

Part Number: HHBK-1



Gear



Gear Kit

Box Contents - Hybrid outer casing, PTFE liner, 2 x PTFE treated gear wires, 8 x CNC Machined ferrules, 2 x Wire end covers

Part Number: HHGK-1



Lightweight Alloy Housing Cable Kits

Lightweight alloy housings with L3 liner, PTFE treated inner wires and CNC machined ferrules. These cable kits are 35% lighter than standard cable kits



Brake

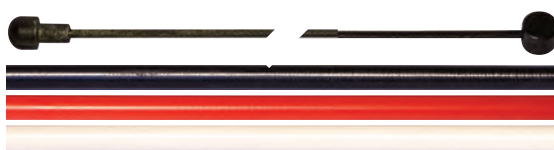

Zero-G Brake Kit

Box Contents - Alloy outer casing, 2 x PTFE treated brake wires, 6 x CNC Machined ferrules, 2 x Wire end covers

Options

Colours - Black, Red or White.

Part Numbers:

Black	Red	White
7160-BLACK	7160-RED	7160-WHITE



Gear



Zero-G Gear Kit

Box Contents - Alloy outer casing, 2 x PTFE treated gear wires, 8 x CNC Machined ferrules, 2 x Wire end covers

Options

Colours - Black, Red or White.

Part Numbers:

Black	Red	White
7161-BLACK	7161-RED	7161-WHITE



Hydraulic disc brakes
4-17

Mechanical disc brakes
18-23

Disc pads
24-29

Rotors
30-35

Calliper brackets
36-39

V-Brakes
40-43

Brake pads & cartridges
44-49

Cable kits & wires
50-57

Cassettes
59

Chains & accessories
60-61

Chainrings
62-63

Bottom brackets
64

Gears
65

Grips
66-75

E-Bike
76-77

Headsets
78-79

Hydraulics
80-87

Service - trays
88-89

Service - Wire, cable & hose
90-91

Service - Parts
92-94

Bottle Cages
95

CABLE KITS & WIRES ■ CABLE KITS

PTFE Cable Kits

Clarks PTFE cable kits come loaded with the latest technology in both design and materials to provide the ultimate performance, using PTFE pre-treated wires massively reduces the friction between the wire and liner giving an all-round smoother operation. The PTFE coating also helps to protect the wire against the weather elements further extending its longevity.



Brake



Brake Kit

Box Contents - 2P Outer casing, 2 x PTFE coated brake wires, 6 x alloy CNC machined ferrules, 2 x rubber frame protectors, 2 x ED black wire end covers, 2 x rubber doughnuts

Part Numbers:

MTB/Hybrid/Road
7138-TEF



Gear



Gear Kit

Box Contents - SP4 Outer casing, 2 x PTFE coated gear wires, 8 x alloy CNC machined ferrules, 2 x rubber frame protectors, 2 x ED black wire end covers, 2 x rubber doughnuts

Part Numbers:

MTB/Hybrid/Road
7139-TEF



Pre-Lubricated with Dirtshield Cable Kits

Clarks Dirtshield, pre-lubricated brake and gear cable kits are engineered to be maintenance free. Ideal for riding in poor weather conditions or where dirt ingress could become an issue. Dirtshield technology seals the inner cable from the elements, making sure that brake feel and gear changes are consistent and reliable at all times. Our Dirtshield braided cable kits are available in a range of metallic colours.

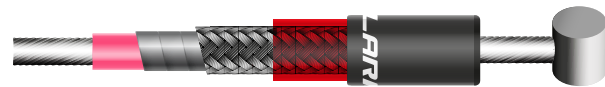

Brake

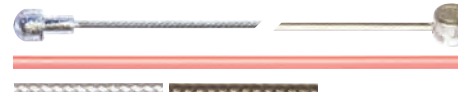

Brake Kit - Braided

Box Contents - 2P Braided outer casing, 2 x pre-lubricated brake wires, 6 x alloy ferrules, 4 x wipe nose ferrules, 2 x rubber frame protectors, 2 x ED black wire end covers, 2 x rubber doughnuts

Options

Colours - Silver, Carbon

Part Numbers:

Silver	Carbon
7138D-SILVER	7143D-CARBON

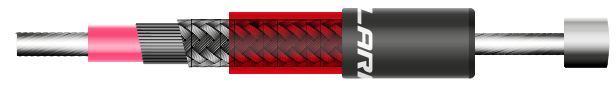

Gear



Gear Kit - Braided

Box Contents - SP4 Braided outer casing, 2 x pre-lubricated brake wires, 8 x alloy ferrules, 6 x wipe nose ferrules, 2 x rubber frame protectors, 2 x ED black wire end covers, 2 x rubber doughnuts

Options

Colours - Silver, Red, Gold, Blue, Carbon

Part Numbers:

Silver	Red	Carbon
7139D-SILVER	7139D-RED	7140D-CARBON
Gold	Blue	
7139D-GOLD	7139D-BLUE	



- Hydraulic disc brakes 4-17
- Mechanical disc brakes 18-23
- Disc pads 24-29
- Rotors 30-35
- Calliper brackets 36-39
- V-Brakes 40-43
- Brake pads & cartridges 44-49
- Cable kits & wires 50-57
- Cassettes 59
- Chains & accessories 60-61
- Chainrings 62-63
- Bottom brackets 64
- Gears 65
- Grips 66-75
- E-Bike 76-77
- Headsets 78-79
- Hydraulics 80-87
- Service - trays 88-89
- Service - Wire, cable & hose 90-91
- Service - Parts 92-94
- Bottle Cages 95

CABLE KITS & WIRES ■ CABLE KITS

Stainless Steel Cable Kits (Braided)

Clarks stainless steel cable kits are available in a wide range of colours. Available in braided outer casings they have proved very popular, providing every rider with the option of colour customisation. All kits include outer casing, stainless steel inner wires, ferrules and crimp on wire end covers.

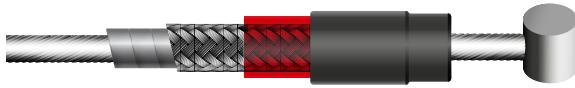

Brake

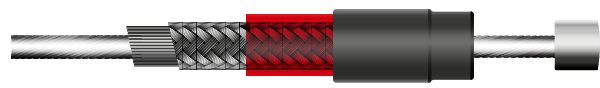
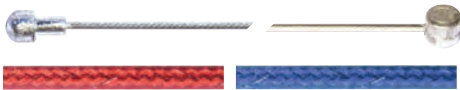

Gear



Brake Kit

Box Contents - 2P Braided outer casing, 2 x stainless steel coated brake wires, 6 x nylon ferrules, 2 x foam frame protectors, 2 x ED black wire end covers, 2 x rubber doughnuts. Stepped steel ferrule.

Options

Colours - Red, Blue

Part Numbers:

Red	Blue
8012-RED-BRAID	8012-BLUE-BRAID

Gear Kit

Box Contents - SP4 Braided outer casing, 2 x stainless steel coated gear wires, 8 x nylon ferrules, 2 x foam frame protectors, 2 x ED black wire end covers, 2 x rubber doughnuts. Stepped steel ferrule.

Options

Colours - Red, Blue

Part Numbers:

Red	Blue
8009-RED-BRAID	8009-BLUE-BRAID

Stainless Steel Cable Kits (Standard)

Clarks stainless steel cable kits are available in a wide range of colours. Available in standard outer casings they have proved very popular, providing every rider with the option of colour customisation. All kits include outer casing, stainless steel inner wires, ferrules and crimp on wire end covers.



Brake

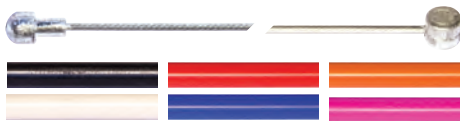

Gear



Brake Kit

Box Contents - 2P Braided outer casing, 2 x stainless steel coated brake wires, 6 x nylon ferrules, 2 x foam frame protectors, 2 x ED black wire end covers, 2 x rubber doughnuts. Stepped steel ferrule.

Options

Colours - Black, Red, Blue, White, Orange, Pink

Part Numbers:

Black	Red	Blue	White
8012-BLACK	8012-RED	8012-BLUE	8012-WHITE
Orange	Pink		
8012-ORANGE	8012-PINK		

Gear Kit

Box Contents - SP4 Braided outer casing, 2 x stainless steel coated gear wires, 8 x nylon ferrules, 2 x foam frame protectors, 2 x ED black wire end covers, 2 x rubber doughnuts. Stepped steel ferrule.

Options

Colours - Black, Red, Blue or White

Part Numbers:

Black	Red	Blue	White
8009-BLACK	8009-RED	8009-BLUE	8009-WHITE

Hydraulic disc brakes
4-17

Mechanical disc brakes
18-23

Disc pads
24-29

Rotors
30-35

Calliper brackets
36-39

V-Brakes
40-43

Brake pads & cartridges
44-49

Cable kits & wires
50-57

Cassettes
59

Chains & accessories
60-61

Chainrings
62-63

Bottom brackets
64

Gears
65

Grips
66-75

E-Bike
76-77

Headsets
78-79

Hydraulics
80-87

Service - trays
88-89

Service - Wire, cable & hose
90-91

Service - Parts
92-94

Bottle Cages
95

CABLE KITS & WIRES ■ CABLE KITS

Galvanised Cable Kits (Standard)

Our galvanised range of cable kits includes the same colour options as the stainless steel kits. This makes colour customisation affordable to every rider. All kits include outer casing, galvanised inner wires, ferrules and crimp on wire end covers

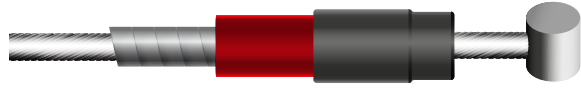

Brake Kit

Box Contents - 2P Braided outer casing, 2 x galvanised steel coated brake wires, 6 x nylon ferrules, 2 x foam frame protectors, 2 x ED black wire end covers, 2 x rubber doughnuts. Stepped steel ferrule.

Options

Colours - Black, Red, or White

Part Numbers:

Black	Red	White
8010-BLACK	8010-RED	8010-WHITE

BMX Cable Kits



Brake Kit - BMX

Pack Contents - Easy glide BMX Slic cable kit with anodised straddle bridge, 2 per pack

Options

Colours - Black

Part Numbers:

Black
CEGCK

Cable Kits & Wires Accessories

Clarks has a range of cable accessories that are supplied in consumer friendly packaging. Ferrule and end cap kits add the finishing touch to all our cable kits, whilst our cable adjusters make fitting, maintenance and adjusting easier.



Gear Cable Adjusters - In-line

- 2 x In-line 4mm gear cable adjusters
- Moulded outer shell for easy adjustment

Part Number: CIGA-01-BLACK



Brake Cable Adjuster - In-line

- 2 x In-line 5mm brake cable adjuster
- Moulded outer shell for easy adjustment

Part Number: CIBA-01-BLACK



Brake Cable Adjuster - In-line

- 2 x In-line 5mm brake cable adjusters
- Moulded outer shell for easy adjustment

Part Number: CIBA-02-BLACK



Ferrule & End Cap Kits

- 6 x 5mm brake ferrules, 8 x 4mm gear ferrules, 2 x wire end covers. All colour matched
- CNC machined, anodised finish

Options

Colours - Black, Blue, Green, Red or Gold

Part Numbers:

Black	Blue	Gold
FB-1-BLACK	FB-1-BLUE	FB-1-GOLD
Green	Red	
FB-1-GREEN	FB-1-RED	

- Hydraulic disc brakes 4-17
- Mechanical disc brakes 18-23
- Disc pads 24-29
- Rotors 30-35
- Calliper brackets 36-39
- V-Brakes 40-43
- Brake pads & cartridges 44-49
- Cable kits & wires 50-57**
- Cassettes 59
- Chains & accessories 60-61
- Chainrings 62-63
- Bottom brackets 64
- Gears 65
- Grips 66-75
- E-Bike 76-77
- Headsets 78-79
- Hydraulics 80-87
- Service - trays 88-89
- Service - Wire, cable & hose 90-91
- Service - Parts 92-94
- Bottle Cages 95

CABLE KITS & WIRES ■ BRAKE & GEAR CABLE KITS

Stainless Steel Brake and Gear Cable Kits

Clarks stainless steel brake and gear cable kits are available with standard outer casings. They provide every rider with a complete set of cables for MTB, Road and Hybrid bikes that are compatible with all major gear and brake systems. All kits include outer casings, stainless steel inner wires, ferrules and crimp on wire end covers.



Brake and Gear Kit -

Box Contents - 2P outer casings, 2 x stainless steel coated brake wires, SP4 outer casings, 2 x stainless steel gear wires, 14 x nylon ferrules, 4 x ED black wire end covers, 4 x rubber doughnuts. Stepped steel ferrule.

Options

Colours - Black or White

Part Numbers:

Black	White
8013-BLACK	8013-WHITE

Galvanised Brake and Gear Cable Kits

Clarks galvanised brake and gear cable kits are available with standard outer casings. They provide every rider with a complete set of cables for MTB, Road and Hybrid bikes that are compatible with all major gear and brake systems. All kits include outer casings, galvanised inner wires, ferrules and crimp on wire end covers.

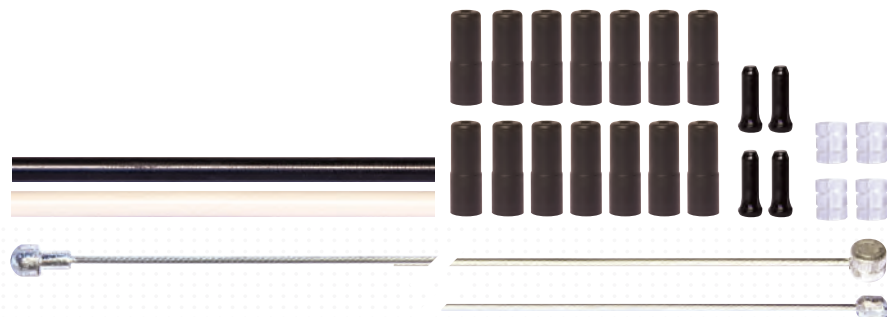

Brake and Gear Kit -

Box Contents - 2P outer casings, 2 x galvanised coated brake wires, SP4 outer casings, 2 x galvanised gear wires, 14 x nylon ferrules, 4 x ED black wire end covers, 4 x rubber doughnuts. Stepped steel ferrule.

Options

Colours - Black

Part Numbers:

Black	White
8014-BLACK	8014-WHITE

Hydraulic disc brakes
4-17

Mechanical disc brakes
18-23

Disc pads
24-29

Rotors
30-35

Calliper brackets
36-39

V-Brakes
40-43

Brake pads & cartridges
44-49

Cable kits & wires
50-57

Cassettes
59

Chains & accessories
60-61

Chainrings
62-63

Bottom brackets
64

Gears
65

Grips
66-75

E-Bike
76-77

Headsets
78-79

Hydraulics
80-87

Service - trays
88-89

Service - Wire, cable & hose
90-91

Service - Parts
92-94

Bottle Cages
95

CABLE KITS & WIRES ■ CABLES

Cables Stainless Steel

Clarks replacement Stainless Steel cables are available with black outer casings and ferrules, supplied individually they fit all cycle component manufactures gear and brake systems.



Brake Cable (Rear)

Pack Contents - 2P Outer casing (length 2000mm), Stainless steel inner wire (length 2100mm)

Part Number: 6086

Gear Cable (Rear)

Pack Contents - SP4 Outer casing (length 1500mm), Stainless steel inner wire (length 2000mm).

Part Number: 6085

Cables Galvanised

Clarks replacement galvanised coated cables are available with black outer casings and ferrules, supplied individually they fit all cycle component manufactures gear and brake systems.



Brake Cable - Front

Pack Contents - 2P Outer casing, Galvanised inner wire.

Part Number: 5094

Brake Cable - Rear

Pack Contents - 2P Outer casing, Galvanised inner wire.

Part Number: 5095

Gear Cable - Sturmey Archer 3 Speed

Cable for Sturmey Archer 3 speed trigger changer
Pack Contents - SP4 Outer casing, Galvanised inner wire and fittings

Part Number: 5085

Gear Cable - Outer Casing

Pack Contents - SP4 Outer casing with ferrules (inner wire not included)

Part Number: IGOC4-2000MM

Hydraulic disc brakes 4-17

Mechanical disc brakes 18-23

Disc pads 24-29

Rotors 30-35

Calliper brackets 36-39

V-Brakes 40-43

Brake pads & cartridges 44-49

Cable kits & wires 50-57

Cassettes 59

Chains & accessories 60-61

Chainrings 62-63

Bottom brackets 64

Gears 65

Grips 66-75

E-Bike 76-77

Headsets 78-79

Hydraulics 80-87

Service - trays 88-89

Service - Wire, cable & hose 90-91

Service - Parts 92-94

Bottle Cages 95

Inner Wires

Clarks inner wires are available in pre-lubricated, PTFE, Die- Drawn, stainless steel and galvanised options - all supplied in generous lengths. They fit all cycle component manufacturers gear and brake systems and are supplied with crimp on wire end covers.

PTFE Coated

Brake - Road

- 1.5mm PTFE coated inner wire.
- Road

Part Number: PW6026R

Brake - MTB/Hybrid

- 1.5mm PTFE coated inner wire.
- MTB, Hybrid

Part Number: BW6026R

Gear - MTB/Hybrid/Road

- 1.1mm PTFE coated inner wire.
- MTB, Hybrid, Road

Part Number: W6021



Die Drawn

Die Drawn wire offers a superbly smooth surface, this is achieved by micro hammering the front end of the cable to the preferred diameter, this is then inserted into a drawing die and pulled through the Draw plate multiple times, resulting in the cable having an ultra-smooth surface. Die Drawn wires greatly reduce the friction between the cable and liner, the end result of this is that die drawn cables perform better than any other cables on the market today.

Brake - Road

- 1.5mm stainless steel die drawn inner wire.
- High performance wire
- Road

Part Number: W6052-DD

Brake - MTB/Hybrid

- 1.5mm stainless steel die drawn inner wire.
- High performance wire
- MTB, Hybrid

Part Number: W6053-DD

Gear - MTB/Hybrid/Road

- 1.1mm stainless steel die drawn inner wire.
- High performance wire

Part Number: W6082-DD



Pre-Lubricated

Brake - MTB/Hybrid

- Maintenance free
- MTB, Hybrid

Part Number: W7138

Brake - Road

- Maintenance free
- 2100mm Length
- MTB, Hybrid

Part Number: W7150

Gear - MTB/Hybrid/Road

- Maintenance free
- MTB, Hybrid, Road

Part Number: W7151

Stainless Steel

Brake - Road

- Stainless steel wire
- 2000mm length
- Road

Part Number: W6052

Brake - MTB/Hybrid

- Stainless steel wire
- 2000mm length
- MTB, Hybrid

Part Number: W6053

Brake - MTB/Hybrid/Road

- Stainless steel wire
- 2100mm length
- MTB, Hybrid, Road

Part Number: W5089SS

Gear - MTB/Hybrid/Road

- Stainless steel wire
- 2275mm length
- MTB, Hybrid, Road

Part Number: W6082

Brake - Tandem MTB/Hybrid/Road

- Stainless steel wire
- 3060mm length
- MTB, Hybrid, Road

Part Number: W5097SS

Gear - Tandem MTB/Hybrid/Road

- Stainless steel wire
- 3060mm length
- MTB, Hybrid, Road

Part Number: W5057/12055

Galvanised

Brake - MTB/Hybrid/Road

- Galvanised inner wire
- 2000mm length
- MTB, Hybrid, Road

Part Number: W5089

Gear - MTB/Hybrid/Road

- Galvanised inner wire
- 2275mm length
- MTB, Hybrid, Road

Part Number: W5056

Hydraulic disc brakes
4-17

Mechanical disc brakes
18-23

Disc pads
24-29

Rotors
30-35

Calliper brackets
36-39

V-Brakes
40-43

Brake pads & cartridges
44-49

Cable kits & wires
50-57

Cassettes
59

Chains & accessories
60-61

Chainrings
62-63

Bottom brackets
64

Gears
65

Grips
66-75

E-Bike
76-77

Headsets
78-79

Hydraulics
80-87

Service - trays
88-89

Service - Wire, cable & hose
90-91

Service - Parts
92-94

Bottle Cages
95



DRIVETRAIN

Clarks range of drivetrain product is extensive, providing for every riding style and capability. From entry level bottom brackets, through to CNC Pro oval chainrings and our new 8-11 speed cassette range - all our drivetrain products combine high quality manufacture with the best materials and bearings available, delivering reliable quality products that provide unrivalled longevity.



QUICK LINK



HOLLOW PLATE



PRECISION ENGINEERED



ANTI RUST



SERVICE & REPAIR PARTS

clarks.bike/order-spare-parts.html



SERVICE & FITTING VIDEOS

clarks.bike/how-to-videos.html



PRODUCT HELPLINE
info@clarks.bike

+44 (0)1455 254800

REAR CASSETTES

Clarks rear cassettes are all manufactured to a high standard, using Nickel plated steel for increased longevity. All Shimano free-hub compatible. Can be fitted using a 12 tooth splined cassette removal/fitting tool.

8 Speed

Shimano compatible, rear cassette, suitable for road, hybrid and MTB bikes.

- Compatible with most 8 speed gear systems (excluding Campagnolo)
- Corrosion resistant steel
- Nickel plated for longevity
- Weight: 260g

Gear Ratio:

8 Speed - 11t, 13t, 15t, 17t, 19t, 21t, 24t, 28t

Part Numbers:	Description:
C-8SC	8 Speed



9 Speed

Shimano compatible, rear cassette, suitable for road, hybrid and MTB bikes.

- Compatible with most 9 speed gear systems (excluding Campagnolo)
- Corrosion resistant steel
- Nickel plated for longevity
- Weight: 325g

Gear Ratio:

9 Speed - 11t, 13t, 15t, 17t, 19t, 21t, 24t, 28t, 32t

Part Numbers:	Description:
C-9SC	9 Speed



10 Speed

Shimano compatible, rear cassette, suitable for road, hybrid and MTB bikes.

- Compatible with most 10 speed gear systems (excluding Campagnolo)
- Corrosion resistant steel
- Nickel plated for longevity
- Weight: 420g

Gear Ratio:

10 Speed - 11t, 13t, 15t, 17t, 19t, 21t, 24t, 28t, 32t, 36t

Part Numbers:	Description:
C-10SC	10 Speed



11 Speed

Shimano compatible, rear cassette, suitable for road, hybrid and MTB bikes.

- Compatible with most 11 speed gear systems (excluding Campagnolo)
- Corrosion resistant steel
- Nickel plated for longevity
- Weight: 539g

Gear Ratio:

11 Speed - 11t, 13t, 15t, 17t, 19t, 21t, 24t, 28t, 32t, 36t, 42t

Part Numbers:	Description:
C-11SC	11 Speed



Hydraulic disc brakes
4-17

Mechanical disc brakes
18-23

Disc pads
24-29

Rotors
30-35

Calliper brackets
36-39

V-Brakes
40-43

Brake pads & cartridges
44-49

Cable kits & wires
50-57

Cassettes
59

Chains & accessories
60-61

Chainrings
62-63

Bottom brackets
64

Gears
65

Grips
66-75

E-Bike
76-77

Headsets
78-79

Hydraulics
80-87

Service - trays
88-89

Service - Wire, cable & hose
90-91

Service - Parts
92-94

Bottle Cages
95

CHAINS & ACCESSORIES

Clarks range of chains is extensive, catering for the requirements of all types of riders. From high performance, narrow 8-11 speed self lubricating chains through to half link single speed and coloured BMX chains, all have proven superior resistance to stretch. This results in less wear to all drive train contact surfaces so maintaining accurate shifting for longer. All our chains are supplied with quick release link chain connectors.

Self Lubricating

At the point of manufacture these chains are coated with a special treatment of PTFE that has good adhesion properties. The 'internal' moving parts of the chain are fully lubricated helping to prevent wear and reducing the requirement for further lubrication. This process significantly increases the life expectancy of the chain and components it comes in contact with.

- Compatible with the major gearing systems including indexed gears.
- Nickel plated for wear and corrosion resistance.
- Self-lubricating technology.
- Top performance and extremely durable.
- Light, yet super rigid giving maximum efficiency.

Options

Speeds - 9, 10, 11 or 12

Part Numbers

No. of gears	Part Number
9	C-CSL9
10	C-CSL10
11	C-CSL11
12	C-CSL12



Anti Rust

Anti Rust chains combine a special surface coating (DACROMET®), which enables the chain to withstand over 500 hours of salt spray testing, significantly greater than a standard chain.

- Compatible with the major gearing systems
- DACROMET® coating
- Low maintenance
- All weather longevity
- Light, yet super rigid giving maximum efficiency

Options

Speeds - Single, 5-7, 8, 9, 10 or 11

Part Numbers

No. of gears	Part Number
Single	C-C410AR
5-7 spd	C-C5-7AR
8 spd	C-C8AR
9 spd	C-C9AR
10 spd	C-C10AR
11 spd	C-C11AR



Standard

Our standard chain is available in sizes from single speed up to 12 speed gearing. A solid performer, this chain offers the rider a good value for money product that will work with all hybrid gear systems on MTB and Road bikes.

- Compatible with the major gearing systems
- Top performance and extremely durable
- Light, yet super rigid giving maximum efficiency

Options

Speeds - Single, 5, 6-8, 9, 10, 11 or 12

Compatibility - 12 Speed chain compatible with SRAM 12 speed including NX Eagle

Part Numbers

No. of gears	Part Number
Single	C-C410
5 spd	C-C5
6-8 spd	C-C6-8
9 spd	C-C9
10 spd	C-C10
11 spd	C-C11
12 spd	C-C12



- Hydraulic disc brakes 4-17
- Mechanical disc brakes 18-23
- Disc pads 24-29
- Rotors 30-35
- Calliper brackets 36-39
- V-Brakes 40-43
- Brake pads & cartridges 44-49
- Cable kits & wires 50-57
- Cassettes 59
- Chains & accessories 60-61
- Chainrings 62-63
- Bottom brackets 64
- Gears 65
- Grips 66-75
- E-Bike 76-77
- Headsets 78-79
- Hydraulics 80-87
- Service - trays 88-89
- Service - Wire, cable & hose 90-91
- Service - Parts 92-94
- Bottle Cages 95

CHAINS & ACCESSORIES

Junior Bike Chain

Single speed standard chain suitable for childrens bikes, 116 links.

- Top performance and extremely durable
- Light, yet super rigid giving maximum efficiency

Options

Speeds - Single

Part Numbers

No. of gears	
Single	C-30



Half Link

With a tensile strength of over 1300kg/f Clarks half link chains have been designed around the requirements of single speed usage. The benefit of consistent tension and better sprocket contact than a 'standard' chain, half link chains provide the single speed user with a smoother ride and offer superior strength.

- Ideal for fixed wheel, track bikes and BMX
- Very strong with consistent tension
- Supplied with quick pin for ease of fitting

Options

Speeds - Single

Colours - Gold

Part Numbers

Speed	Colour	
Single	Gold	CL918G2HL



Split Links

Easy to install, these split links will allow the chain to be removed and refitted without the need for chain rivet extractors. Designed to be compatible with all major gearing systems, the Clarks split link will not impede the operation of a cycle's drive-train.

- Compatible with the major gearing systems
- Extremely durable
- Easy fitting
- Light, yet super rigid giving maximum efficiency
- Re-usable
- Available in single packs or packs of 2

Options

Speeds - Single, 5-8, 9, 10, 11 or 12

Part Numbers

Single	8 Speed	9 Speed	10 Speed	11 Speed	12 Speed
C-CL410	C-CL5-8	C-CL9	C-CL10	C-CL11	C-CL12
C-CL410X2	C-CL5-8X2	C-CL9X2	C-CL10X2	C-CL11X2	C-CL12X2



Hydraulic disc brakes
4-17

Mechanical disc brakes
18-23

Disc pads
24-29

Rotors
30-35

Calliper brackets
36-39

V-Brakes
40-43

Brake pads & cartridges
44-49

Cable kits & wires
50-57

Cassettes
59

Chains & accessories
60-61

Chainrings
62-63

Bottom brackets
64

Gears
65

Grips
66-75

E-Bike
76-77

Headsets
78-79

Hydraulics
80-87

Service - trays
88-89

Service - Wire, cable & hose
90-91

Service - Parts
92-94

Bottle Cages
95

CHAINRINGS

Our chainring range consists of a chainring to suit every rider, we offer a wide range of sizes and mount types, and also offer both circular and oval chainrings. All of our chainrings are constructed from 7075 Grade alloy. This ensures that they are strong in construction but also remain light, each one is individually CNC machined to precise measurements so you can rest assured the quality of the finished product is to the very highest standard that rivals all leading manufacturers.

Standard

Standard Fitment - Wide/Narrow Teeth

- Compatible with 9-11 Speed
- Available in 104 BCD

Options

Sizes - 104mm bolt centre diameter.
 Number of teeth - 30, 32, 34, 36 and 38
 Colours - Black

Part Numbers

No. of teeth	104mm BCD
30	CCR-03-30-BLACK
32	CCR-03-32-BLACK
34	CCR-03-34-BLACK
36	CCR-03-36-BLACK
38	CCR-03-38-BLACK



Pro

Standard Fitment - Wide/Narrow Teeth

- Compatible with 9-11 Speed
- Available in 94 BCD

Options

Sizes - 94mm bolt centre diameter, 104mm bolt centre diameter.
 Number of teeth - 30, 32, 34, 36 and 38
 Colours - Black

Part Numbers

No. of teeth	94mm BCD
30	CCR-94A-01-30-BLACK
32	CCR-94A-01-32-BLACK
34	CCR-94A-01-34-BLACK
36	CCR-94A-01-36-BLACK
38	CCR-94A-01-38-BLACK



Oval

Standard Fitment - Wide/Narrow Teeth

- Compatible with 9-11 Speed
- Available in 104 BCD

Options

Sizes - 94mm bolt centre diameter, 104mm bolt centre diameter.
 Number of teeth - 32 and 34
 Colours - Black

Part Numbers

No. of teeth	104mm BCD
32	CCR-03-OV-32-BLACK
34	CCR-03-OV-34-BLACK



- Hydraulic disc brakes 4-17
- Mechanical disc brakes 18-23
- Disc pads 24-29
- Rotors 30-35
- Calliper brackets 36-39
- V-Brakes 40-43
- Brake pads & cartridges 44-49
- Cable kits & wires 50-57
- Cassettes 59
- Chains & accessories 60-61
- Chainrings 62-63
- Bottom brackets 64
- Gears 65
- Grips 66-75
- E-Bike 76-77
- Headsets 78-79
- Hydraulics 80-87
- Service - trays 88-89
- Service - Wire, cable & hose 90-91
- Service - Parts 92-94
- Bottle Cages 95

Pro

Direct Fitment - Wide/Narrow Teeth

- Compatible with 9-11 Speed

Options

Number of teeth - 30, 32, 34 and 36

Colours - Black

Part Numbers

No. of teeth	Direct fitment
30	CCR-04-30-BLACK
32	CCR-04-32-BLACK
34	CCR-04-34-BLACK
36	CCR-04-36-BLACK

Taiwan



Oval

Direct Fitment - Wide/Narrow Teeth

- Compatible with 9-11 Speed

Options

Number of teeth - 32 and 34

Colours - Black

Part Numbers

No. of teeth	Direct fitment
32	CCR-04-OV-32-BLACK
34	CCR-04-OV-34-BLACK

Taiwan



Hydraulic disc brakes
4-17

Mechanical disc brakes
18-23

Disc pads
24-29

Rotors
30-35

Calliper brackets
36-39

V-Brakes
40-43

Brake pads & cartridges
44-49

Cable kits & wires
50-57

Cassettes
59

Chains & accessories
60-61

Chainrings
62-63

Bottom brackets
64

Gears
65

Grips
66-75

E-Bike
76-77

Headsets
78-79

Hydraulics
80-87

Service - trays
88-89

Service - Wire, cable & hose
90-91

Service - Parts
92-94

Bottle Cages
95

BOTTOM BRACKETS

Our range of bottom brackets provides both entry level and high end ranges in all major sizes. Clarks Bottom brackets are manufactured from some of the finest alloys available, using bearings of the highest quality to ensure smooth operation and unrivalled longevity.

Press Fit Sealed Bearing - Alloy

- CNC Machined.
- Suitable for 86, 90 & 92mm wide frame shells.

Options

Axle sizes - 22mm, 24mm

Colours - Red, Green, Gold, Blue & Black

Part Numbers

Colours	22mm Axle	24mm Axle
Red	-	CBB-501-24-RED
Green	-	CBB-501-24-GREEN
Gold	-	CBB-501-24-GOLD
Blue	-	CBB-501-24-BLUE
Black	CBB-501-22-BLACK	CBB-501-24-BLACK



Threaded Sealed Bearing - Alloy

- CNC Machined.
- Suitable for 68-73mm wide frame shells.

Options

Axle sizes - 22mm, 24mm

Colour - Black

Part Numbers

Colours	22mm Axle	24mm Axle
Black	CBB-51-22	CBB-51-24



Press Fit Sealed Bearing - Alloy

- CNC Machined, press fit all alloy.
- Suitable for 86, 90, 92mm wide frame shells.

Options

Axle sizes - 22mm, 24mm

Colour - Black

Part Numbers

Frame shell width	22mm Axle	24mm Axle
86mm	CBB-86-22	CBB-86-24
90mm	CBB-90-22	CBB-90-24
92mm	CBB-92-22	CBB-92-24



Threaded Sealed Bearing - Alloy

- External bottom bracket made for threaded bottom brackets.
- Suitable for 68, 73, 83 & 100mm wide frame shells.

Options

Axle sizes - 24mm

Colours - Red, Green, Gold, Blue & Black

Part Numbers

Colours	24mm Axle
Red	CBB-401-RED
Green	CBB-401-GREEN
Gold	CBB-401-GOLD
Blue	CBB-401-BLUE
Black	CBB-401-BLACK



Square Taper Threaded Cups Sealed Bearing - Steel/Alloy

- Phosphate treated cups.
- Suitable for 68mm wide frame shells.
- Available with 110.5, 113.5, 115, 116, 118, 122.5 and 124 axle length.

Options

Colour - Black

Part Numbers

Axle length	68mm width	Axle length	68mm width
110.5	CBB-910-110.5	118	CBB-910-118
113.5	CBB-910-113.5	122.5	CBB-910-122.5
115	CBB-910-115	124	CBB-910-124
116	CBB-910-116		



- Hydraulic disc brakes 4-17
- Mechanical disc brakes 18-23
- Disc pads 24-29
- Rotors 30-35
- Calliper brackets 36-39
- V-Brakes 40-43
- Brake pads & cartridges 44-49
- Cable kits & wires 50-57
- Cassettes 59
- Chains & accessories 60-61
- Chainrings 62-63
- Bottom brackets 64**
- Gears 65
- Grips 66-75
- E-Bike 76-77
- Headsets 78-79
- Hydraulics 80-87
- Service - trays 88-89
- Service - Wire, cable & hose 90-91
- Service - Parts 92-94
- Bottle Cages 95

GEARS ■ DERAILLEURS & LEVERS

REAR DERAILLEURS

Clarks rear durailleurs are designed to work with Shimano indexed gear systems. Suitable for MTB, hybrid and road bikes they are available for 6, 7, 8 and 9 speed gearing with capacities up to 34T.

- Shimano gear system, compatible
- Works with indexed levers
- 6, 7, 8 and 9 Speed changers
- Gear capacity, 6 speed 11T to 32T, 7, 8 and 9 speed 11T to 34T

Options

Speeds - 6, 7, 8 and 9 Speed

Colour - Black

Part Numbers

Part Number	Number of Gears	Gear capacity
C-6SRD	6 Speed	11T - 32T
C-7SRD	7 Speed	11T - 34T
C-8SRD	8 Speed	11T - 34T
C-9SRD	9 Speed	11T - 34T

FRONT DERAILLEURS

Clarks front durailleurs are designed to work with Shimano indexed gear systems. Dual pull, with clamp on fixings, the changers are suitable for MTB, and hybrid bikes they are available for 7,8 and 9 speed gearing with a maximum chain ring size of 42T and a gear capacity of 18T.

- Shimano gear system, compatible
- Works with indexed levers
- 7, 8 and 9 speed gear systems
- Gear capacity - 18T
- Maximum chain ring size - 42T
- Dual pull

Options

Speeds - 6, 7, 8 and 9 Speed

Colour - Black

Part Numbers

Part Number	Number of Gears	Gear capacity	Chain ring size
C-7SRD	7 Speed	18T	42T
C-8SRD	8 Speed	18T	42T
C-9SRD	9 Speed	18T	42T

LEVERS

Clarks trigger gear levers, are indexed to work with all Shimano gear systems. Rear levers are available for 7, 8 and 9 speed gear systems, front levers for triple chain rings. Suitable for MTB and hybrid bikes the levers have gear number indicators

- Shimano gear system, compatible
- Work with indexed gear systems
- 7, 8 and 9 speed rear gear systems
- Triple chain front changer
- Trigger operation
- Gear number indicator
- Gear wire included (2100mm)

Options

Speeds - 7, 8 and 9 Speed

Colour - Black

Part Numbers

Part Number	Number of Gears	Front / Rear
C-7SSL	3 Chain rings	Front
C-7SSR	7 Speed	Rear
C-8SSR	8 Speed	Rear
C-9SSR	9 Speed	Rear



Hydraulic disc brakes
4-17

Mechanical disc brakes
18-23

Disc pads
24-29

Rotors
30-35

Calliper brackets
36-39

V-Brakes
40-43

Brake pads & cartridges
44-49

Cable kits & wires
50-57

Cassettes
59

Chains & accessories
60-61

Chainrings
62-63

Bottom brackets
64

Gears
65

Grips
66-75

E-Bike
76-77

Headsets
78-79

Hydraulics
80-87

Service - trays
88-89

Service - Wire, cable & hose
90-91

Service - Parts
92-94

Bottle Cages
95



CLARKS
EXCEED YOUR LIMITATIONS



GRIPS

The importance of a quality grip is often overlooked by cyclists and cycle manufacturers. Hands are one of the main points of contacts with the cycle. They experience considerable levels of vibration and shock which is in-turn transferred through to the wrist joint. Fatigue, numbness and wrist pain can be avoided by selecting a good quality grip that is fit for purpose. Clarks has a comprehensive range of grips, all manufactured to a high standard and easy to fit, as well as available in many colours and with locking ring options. We are confident that we have a grip that caters for any riding style.



SERVICE & REPAIR PARTS

clarks.bike/order-spare-parts.html



SERVICE & FITTING VIDEOS

clarks.bike/how-to-videos.html



PRODUCT HELPLINE
info@clarks.bike

+44 (0)1455 254800

LOCK-ON & ERGONOMIC GRIP HARDNESS

Grip density and resultant ability to absorb shock, preventing wrist and nerve damage to riders hands is a key measurement of product effectiveness.

- Ergonomic Grip density - SHOA 40-45
- Lock-On Grip density - SHOA 25-30



VIBRATION ABSORPTION



ANTI-SLIP TECH



ERGONOMIC



EASY FIT

Hydraulic disc brakes
4-17

Mechanical disc brakes
18-23

Disc pads
24-29

Rotors
30-35

Calliper brackets
36-39

V-Brakes
40-43

Brake pads & cartridges
44-49

Cable kits & wires
50-57

Cassettes
59

Chains & accessories
60-61

Chainrings
62-63

Bottom brackets
64

Gears
65

Grips
66-75

E-Bike
76-77

Headsets
78-79

Hydraulics
80-87

Service - trays
88-89

Service - Wire, cable & hose
90-91

Service - Parts
92-94

Bottle Cages
95

GRIPS ■ LOCK-ON

Clarks LOCK-ON grips are constructed with a polypropylene (PP) inner sleeve coated with thermo plastic rubber (TPS) to provide a hard wearing and positive feel. Aluminium locking rings then secure firmly to the handle bar preventing any rotational movement of the grip. Available in a range of grip colours and anodised aluminium ring finishes, complete with matching end plugs, Clarks Lock-On grips will enhance any MTB or Hybrid bike.



CLO-201

- Black Lock-On grip with anodised end
- Dual grip pattern

Options - Locking ring and grip colour customisation available - [See page 69](#)

Black/Red	Black/Black
CLO-201-BLK-ANO-RED	CLO-201-B
Black/Silver	
CLO-201-S	



CLO-208

- Comfortable main body, 130mm
- Unique raised grip surface offering shock absorption properties and ventilation

Options - Locking ring and grip colour customisation available - [See page 69](#)

Black/Blue	Black/Red
CLO-208-BLACK-BLUE	CLO-208-BLACK-RED
Black/White	
CLO-208-BLACK-WHITE	



CLO-210

- Comfortable main body, 130mm
- Increased rubber depth on palm area

Options - Locking ring and grip colour customisation available - [See page 69](#)

White
CLO-210



CLO-211

- Comfortable main body, 130mm
- Unique raised grip surface offering shock absorption properties and ventilation

Options - Locking ring and grip colour customisation available - [See page 69](#)

Black
CLO-211-BLACK



CLO-215

- Carbon bar tape appearance

Options - Locking ring and grip colour customisation available - [See page 69](#)

Black	Carbon
CLO-215-BLACK	CLO-215-CARBON



CLO-216

- Lock-On grip 130mm Length
- 1 locking ring per grip

Options - Locking ring and grip colour customisation available - [See page 69](#)

Red
CLO-216-RED



CLO-217

- Dimple surface for effective cushioning
- Raised central area for improved palm support

Options - Locking ring and grip colour customisation available - [See page 69](#)

Black
CLO-217-BLACK



CLO-219

- Black styled raised rubber body for maximum shock absorption and overall improved grip

Options - Locking ring and grip colour customisation available - [See page 69](#)

Black	White
CLO-219-BLACK	CLO-219-WHITE



CLO-220

- Stitched lock on grips

Black	Brown
CLO-220-BLACK	CLO-220-BROWN

- Hydraulic disc brakes 4-17
- Mechanical disc brakes 18-23
- Disc pads 24-29
- Rotors 30-35
- Calliper brackets 36-39
- V-Brakes 40-43
- Brake pads & cartridges 44-49
- Cable kits & wires 50-57
- Cassettes 59
- Chains & accessories 60-61
- Chainrings 62-63
- Bottom brackets 64
- Gears 65
- Grips 66-75**
- E-Bike 76-77
- Headsets 78-79
- Hydraulics 80-87
- Service - trays 88-89
- Service - Wire, cable & hose 90-91
- Service - Parts 92-94
- Bottle Cages 95

GRIPS ■ LOCK-ON



CLO-222

- Comfortable EVA foam surface ideal for wet weather riding
- Lightweight locking grips that are very resilient to poor conditions
- Grip length - 130mm

Options - Locking ring and grip colour customisation available - [See page 69](#)

Red	Blue
CLO-222-BLACK-RED	CLO-222-BLACK-BLUE



CLO-223

- Comfortable neoprene surface ideal for wet weather riding
- Raised central area for improved palm support
- Very Lightweight at 82g a pair

Options - Locking ring and grip colour customisation available - [See page 69](#)

Black/Black
CLO-223



CLO-224

- Comfortable neoprene surface, 130mm
- Extremely lightweight at 71g a pair
- Recessed design to improve 'grip' leverage

Options - Locking ring and grip colour customisation available - [See page 69](#)

Black/Red	Black/Black
CLO-224-BLACK-RED	CLO-224-BLACK-BLACK



CLO-240

- Wave appearance anti slide double locking ring
- Open end with end cap Lock on grip
- 22mm x 130mm MTB grip

Black
CLO-240



CLO-275

- Comfortable main body with micro flange surface for improved shock absorption
- Small flange edge to ensure easy access to shifters

Options - Locking ring and grip colour customisation available - [See page 69](#)

Black
CLO-275



CLO-276

- Raised diamond pattern surface for increased grip and improved comfort
- Grip length - 130mm

Options - Locking ring and grip colour customisation available - [See page 69](#)

Black	Brown
CLO-276-BLACK	CLO-276-BROWN



CLO-309

- Comfortable main body, 130mm
- Solid rubber surface

Options - Locking ring and grip colour customisation available - [See page 69](#)

Black
CLO-309

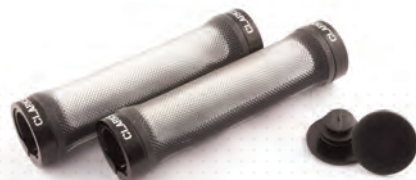

CLO-309T

- Comfortable main body, 130mm
- Transparent grip surface
- Recessed design to improve 'grip' leverage

Options - Locking ring and grip colour customisation available - [See page 69](#)

Transparent
CLO-309T



CLO-G308

- Comfortable main body, 130mm
- Increased rubber depth on palm area

Options - Locking ring and grip colour customisation available - [See page 69](#)

Black/Grey
CLO-G308

Hydraulic disc brakes
4-17

Mechanical disc brakes
18-23

Disc pads
24-29

Rotors
30-35

Calliper brackets
36-39

V-Brakes
40-43

Brake pads & cartridges
44-49

Cable kits & wires
50-57

Cassettes
59

Chains & accessories
60-61

Chainrings
62-63

Bottom brackets
64

Gears
65

Grips
66-75

E-Bike
76-77

Headsets
78-79

Hydraulics
80-87

Service - trays
88-89

Service - Wire, cable & hose
90-91

Service - Parts
92-94

Bottle Cages
95

GRIPS ■ LOCK-ON



CS-001

- Silicone grips have the ability to adapt to the shape of your palm providing unrivalled support and control
- 100% Non-slip double locking rings for secure fitment

Black/Red
CS-001-BLACK-RED



CS-003

- Silicone grips have the ability to adapt to the shape of your palm providing unrivalled support & control
- 100% Non-slip double locking rings for secure fitment

Green/Black
CS-003

GRIPS ERGONOMIC

Our range of ergonomic grips feature profiles that support the riders' hand with a larger contact area, thereby spreading out the vibration and shock carried through the grip making them more comfortable than a grip with a circular profile. Using various materials, styles and colours, these grips are primarily intended for use on Hybrid and City cycles.



CL-G206

- Ergonomically designed grip for comfort
- Detachable alloy bar ends
- 100% Non-slip alloy locking rings

Black
CL-G206



CS-002

- Ergonomic design for increased comfort
- Silicone grips have the ability to adapt to the shape of your palm providing unrivalled support & control
- 100% Non-slip single locking rings for secure fitment

Black
CS-002



CE-205

- Comfortable main body with integrated bar ends, 130mm
- Integrated locking ring for a smooth clean look, with 100% non-slip

Options - Locking ring and grip colour customisation available - [See page 69](#)

Black/Grey
CE-205



CE-212

- Comfortable main body, 130mm
- Ergonomic design for increased comfort
- Integrated double alloy lock clamp 100% non-slip

Options - Locking ring and grip colour customisation available - [See page 69](#)

Black
CE-212-BLACK



CE-233

- 2 Tone rubber ergonomic grip that provides superb palm support. Features integrated locking ring to hold it secure on the handlebar.
- Rubber Surface
- Integrated Locking Rings
- Bar-ends supplied where appropriate

Black/Grey
CE-233



CE-234-CORK

- Cork ergonomic styled grip that provides superb palm support. Features an integrated locking ring to hold it secure on the handlebar.
- Cork Surface
- Integrated Locking Rings
- Bar-ends supplied where appropriate

Brown Cork
CE-234-CORK

- Hydraulic disc brakes 4-17
- Mechanical disc brakes 18-23
- Disc pads 24-29
- Rotors 30-35
- Calliper brackets 36-39
- V-Brakes 40-43
- Brake pads & cartridges 44-49
- Cable kits & wires 50-57
- Cassettes 59
- Chains & accessories 60-61
- Chainrings 62-63
- Bottom brackets 64
- Gears 65
- Grips 66-75**
- E-Bike 76-77
- Headsets 78-79
- Hydraulics 80-87
- Service - trays 88-89
- Service - Wire, cable & hose 90-91
- Service - Parts 92-94
- Bottle Cages 95

GRIPS • ERGONOMIC



CE-235

- Leather grip that provides superb palm support. Features an integrated locking ring to hold it secure on the handlebar.
- Leather surface
 - Integrated locking rings

Black Leather
CE-235



CE-242

- Ergonomic grip with good palm support and grooved grip pattern.
- Integrated single side locking rings
 - Thermo-plastic resin
 - Length 140mm

Black
CE-242-BLACK



CE-311

- Comfortable main body with detachable bar ends, 130mm
- Double alloy lock clamp 100% non-slip
- Locking ring in anodised finish

Black/Grey
CE-311

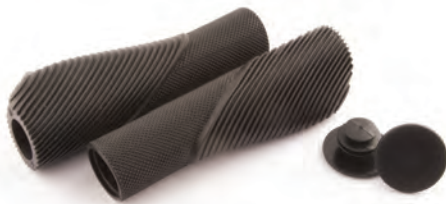

CE-303

- Comfortable main body, 130mm
- Micro flanged area or improved shock absorption

Black
CE-303-BLACK



CE-312

- Ergonomic grip with good palm support and grooved grip pattern.
- Integrated double side locking rings
 - Thermo-plastic resin
 - Length 132mm

Black
CE-312-BLK



CE-315

- Two tone ergonomic grip with good palm support.
- Integrated single side locking rings
 - Thermo-plastic resin
 - Length 135mm

Black/Grey
CE-315-BLACK-GREY



C310-LEATHER

- Comfortable main body, 130mm
- Leather city grip with black stitching
- 130mm Grip length

Brown Leather
C310-LEATHER



C310-PU

- Comfortable main body, 130mm
- Stitched PU material
- 130mm Grip length

White
C310-PU



CL-301

- Two tone ergonomic grip with good palm support.
- Thermo-plastic resin
 - Length 135mm

Black/Grey
CL-301

GRIP ENDS & LOCKING RINGS

Clarks supply lock on bar end extensions that compliment our range of locking rings and caps that can be used with out standard end caps.



Locking Ring

- Universal locking ring
- Strong lightweight alloy construction
- Alloy lock clamp 100% non-slip
- Anodised finish

Black
CLR-CF-BLACK



Alloy Bar Ends

- Ergonomic design for increased comfort
- Alloy construction for reduced weight and durability
- Anodised finish
- Lock clamp 100% non-slip

Black
CB-02-BLACK

Hydraulic disc brakes
4-17

Mechanical disc brakes
18-23

Disc pads
24-29

Rotors
30-35

Calliper brackets
36-39

V-Brakes
40-43

Brake pads & cartridges
44-49

Cable kits & wires
50-57

Cassettes
59

Chains & accessories
60-61

Chainrings
62-63

Bottom brackets
64

Gears
65

Grips
66-75

E-Bike
76-77

Headsets
78-79

Hydraulics
80-87

Service - trays
88-89

Service - Wire, cable & hose
90-91

Service - Parts
92-94

Bottle Cages
95

GRIPS ■ COMFORT

Our range of comfort grips are designed for the recreational cyclist. Using rubber and neoprene for the contact surface these grips will provide long lasting use through all weather conditions.

- Hydraulic disc brakes 4-17
- Mechanical disc brakes 18-23
- Disc pads 24-29
- Rotors 30-35
- Calliper brackets 36-39
- V-Brakes 40-43
- Brake pads & cartridges 44-49
- Cable kits & wires 50-57
- Cassettes 59
- Chains & accessories 60-61
- Chainrings 62-63
- Bottom brackets 64
- Gears 65
- Grips 66-75**
- E-Bike 76-77
- Headsets 78-79
- Hydraulics 80-87
- Service - trays 88-89
- Service - Wire, cable & hose 90-91
- Service - Parts 92-94
- Bottle Cages 95



C-132

- 168mm Length
- Includes plugs

Black	Blue
C-132-BLACK	C-132-BLUE
Black/Grey	
C-132-BLACK-GREY	



C-98-130

- 130mm Length
- Includes plugs

Black	Blue
C-98-130-BLACK	C-98-130-BLUE
Green	Red
C-98-130-GREEN	C-98-130-RED



C-98-92

- 92mm Length
- Includes plugs

Black
C-98-92



C05

- 130mm Length
- Neoprene surface for comfort and weight reduction and resilience to wet weather
- Includes plugs

Black/Grey
C05



C106

- 130mm Length
- Grip surface improves comfort and ventilation

Black/Grey
C106



C121

- 123mm Length
- Closed end Thermo-plastic resin grip

Black
C121-BLACK



C122-CORK

- Ergonomic design for increased comfort
- High concentration of cork compound offers high shock absorption properties for increased comfort

Cork
C122-CORK



C125

- Two layer rubber grips provide superb comfort
- Closed end helps to protect end of bars

Black/Green
C125



C127

- Slide on rubber grip
- Flanged surface for increased comfort

Orange/Black
C127



C135

- 168mm Length
- Octagonal profile grip
- Includes plugs

Black	Red
C135-BLACK	C135-RED

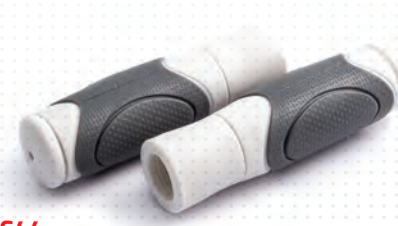

C44

- 92mm length
- Ergonomic design for increased comfort

Black/Grey
C44



C76

- 130mm length
- Closed end Thermo plastic resin grip

Black
C76

GRIPS • COMFORT



C47

- 90mm Length
- Includes plugs

Black
C47



C49

- 130mm Length
- Includes plugs

Black/Grey	Black/Red
C49	C49-RB



CL-G305

- 130mm Length
- Includes plugs

Black/Grey
CL-G305



C82-CORK

- Ergonomic design for increased comfort
- Rubber/Cork compound offers increased comfort and longevity

Cork/Black
C82-CORK



CL-GR14

- Sport foam grips
- 4 grips including plugs

Black
CL-GR14



CS-004

- Silicone grips have the ability to adapt to the shape of your palm providing unrivalled support & control
- 130mm length

Black	Blue
CS-004	CS-004-BLUE
Green	Red
CS-004-GREEN	CS-004-RED

Hydraulic disc brakes
4-17

Mechanical disc brakes
18-23

Disc pads
24-29

Rotors
30-35

Calliper brackets
36-39

V-Brakes
40-43

Brake pads & cartridges
44-49

Cable kits & wires
50-57

Cassettes
59

Chains & accessories
60-61

Chainrings
62-63

Bottom brackets
64

Gears
65

Grips
66-75

E-Bike
76-77

Headsets
78-79

Hydraulics
80-87

Service - trays
88-89

Service - Wire, cable & hose
90-91

Service - Parts
92-94

Bottle Cages
95

LOCK-ON GRIPS CUSTOMISATION

A selection of our lock-on grips have the option of customising the grip body and locking ring to a colour of your choice from the options below.

Grip body colour options



BLACK

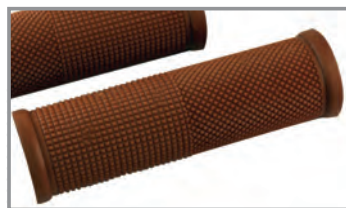

BROWN



WHITE

Locking ring colour options



GREEN



SILVER



RED



BLACK



GOLD



BLUE

GRIPS ■ BMX

Our range of BMX grips feature profiles that support the riders' hand with a larger contact area, thereby spreading out the vibration and shock carried through the grip making them more comfortable than a grip with a circular profile.

- Hydraulic disc brakes 4-17
- Mechanical disc brakes 18-23
- Disc pads 24-29
- Rotors 30-35
- Calliper brackets 36-39
- V-Brakes 40-43
- Brake pads & cartridges 44-49
- Cable kits & wires 50-57
- Cassettes 59
- Chains & accessories 60-61
- Chainrings 62-63
- Bottom brackets 64
- Gears 65
- Grips 66-75**
- E-Bike 76-77
- Headsets 78-79
- Hydraulics 80-87
- Service - trays 88-89
- Service - Wire, cable & hose 90-91
- Service - Parts 92-94
- Bottle Cages 95



C83

- 130mm in length
- Open ended grip supplied with black end caps
- Diamond grip pattern for good grip
- End caps supplied

Black	Blue	Yellow
C83-BLACK	C83-BLUE	C83-YELLOW
Pink	Orange	Red
C83-PINK	C83-ORANGE	C83-RED
White		
C83-WHITE		



C83-OE

- 130mm in length
- Diamond grip pattern for good grip
- Closed end design

Black
C83-OE-BLACK



C100

- 145mm in length
- Open ended grip supplied with black expanding end caps
- Large flanged design

Black	Green	Red
C100-BLACK	C100-GREEN	C100-RED
Grey	Pink	White
C100-GREY	C100-PINK	C100-WHITE



C105

- 130mm in length
- Micro flange design for improved grip and impact absorption
- End caps supplied
- Ribbed grip surface

Black	Green
C105-BLACK	C105-GREEN

Grips | BMX Colour range



GRIPS ■ BAR TAPE

All Clarks handle bar tape sets include two rolls of tape, black handle bar end caps and black finishing tape with a Clarks repeated motif. The cushioned tape is supplied in generous lengths of 210cm, more than enough to provide a good overlap and high shock absorption qualities.



CHBT-2810

- Highly durable and hard wearing
- Raised 'Snake skin' pattern for added grip
- High shock absorption qualities
- Super flexible making installation easy

Black
CHBT-2810



CHBT-2812

- Highly durable and hard wearing
- Plain black grip
- High shock absorption qualities
- Super flexible making installation easy

Black
CHBT-2812

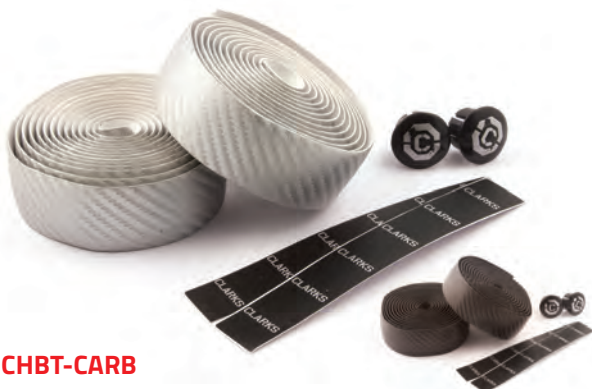

CHBT-CARB

- Carbon pattern finish
- Highly durable and hard wearing
- High shock absorption qualities
- Synthetic surface easy to keep clean

Black	Silver
CHBT-CARB-BLACK	CHBT-CARB-SILVER

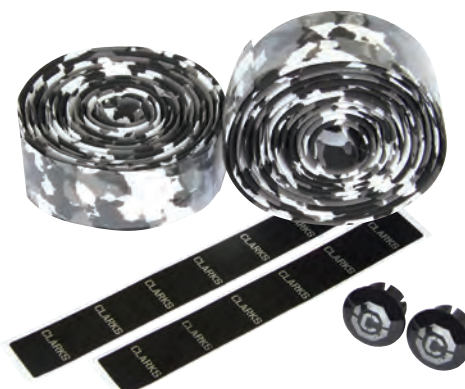

CHBT-28

- EVA Mixed colour bar tape pattern
- Offers superb comfort and flexibility
- High shock absorption qualities
- Super flexible making installation easy

Red/Black	White/Black
CHBT-28-RED-BLACK	CHBT-28-WHITE-BLACK
Yellow/Black	
CHBT-28-YELLOW-BLACK	



CHBT

- Plain tape available in various colour options
- Highly durable and hard wearing
- High shock absorption qualities
- Super flexible making installation easy

Black	Blue	Brown
CHBT-BLACK	CHBT-BLUE	CHBT-BROWN
Green	Red	White
CHBT-GREEN	CHBT-RED	CHBT-WHITE
Yellow		
CHBT-YELLOW		



- Hydraulic disc brakes 4-17
- Mechanical disc brakes 18-23
- Disc pads 24-29
- Rotors 30-35
- Calliper brackets 36-39
- V-Brakes 40-43
- Brake pads & cartridges 44-49
- Cable kits & wires 50-57
- Cassettes 59
- Chains & accessories 60-61
- Chainrings 62-63
- Bottom brackets 64
- Gears 65
- Grips 66-75**
- E-Bike 76-77
- Headsets 78-79
- Hydraulics 80-87
- Service - trays 88-89
- Service - Wire, cable & hose 90-91
- Service - Parts 92-94
- Bottle Cages 95



E-BIKE ■ HYDRAULIC DISC BRAKE SET

All Clarks hydraulic disc brakes are approved to ISO4210

e-CLOUT

The e-Clout, Clarks new hydraulic brake system has 22mm pistons which provide greater power and control. These self adjusting pistons provide greater stopping force making it the ideal brake set for E-bikes and MTB's. Built on the success of the M Series brake sets, the e-Clout features semi-metallic pads, for improved wear and control, lever reach adjustment and mineral oil fluid.

- Lightweight brake system for E-bikes and MTB's
- Self adjusting 22mm calliper pistons for greater stopping force
- 3 Finger lever for greater braking force and control at the lever
- Semi-metallic pads for improved wear characteristics and control
- Lever reach adjustment to suit all hand sizes
- International standard and Post mount fit
- Mineral oil fluid to protect the environment
- Stainless steel rotors
- Spare olives to allow for hose reduction
- Weight - 300g

Box Contents:

Front and rear sets - 2 x Callipers, 2 x levers, 2 x rotors & bolts, pads & hoses.

Replacement Part Numbers:

Rotor - TL-027 - [See page 32](#)

Pads - VX811, VRX811, EVRS811 - [See page 77](#)

Options available:

Part Numbers:	Description:
HY21EF180PMR160ISBAMROW	Front 180mm PM Rear 160mm IS set



NEW
2022



E-BIKE ■ MECHANICAL DISC BRAKE SET

All Clarks hydraulic disc brakes are approved to ISO4210

CMD-24

Clarks E-Bike mechanical disc brake calliper, manufactured in aluminium alloy, features wider disc pads for greater efficiency and stopping power.

- Suitable for e-bikes
- Compatible with MTB/Hybrid bikes
- IS & PM compatible
- Lightweight design
- Built in adjustment
- Lightweight 269g (including rotor)

Box Contents:

Front and rear sets - 2 x Callipers, 2 x rotors, 12 x rotor bolts & pads.

Replacement Part Numbers:

Rotor - TL-027 - [See page 32](#)

Pads - VX824, VRX824, VRS824 - [See page 27](#)

Options available:

Part Numbers:	Description:
CMD-24-F&R-180/160	Front 180 & Rear 160mm set



Hydraulic disc brakes
4-17

Mechanical disc brakes
18-23

Disc pads
24-29

Rotors
30-35

Calliper brackets
36-39

V-Brakes
40-43

Brake pads & cartridges
44-49

Cable kits & wires
50-57

Cassettes
59

Chains & accessories
60-61

Chainrings
62-63

Bottom brackets
64

Gears
65

Grips
66-75

E-Bike
76-77

Headsets
78-79

Hydraulics
80-87

Service - trays
88-89

Service - Wire, cable & hose
90-91

Service - Parts
92-94

Bottle Cages
95

E-BIKE ■ DISC PADS

Semi-Metallic disc brake pads with high carbon content for E-bike disc brakes. The pad compound is specifically suitable for E-bikes, having high brass/iron content for powerful braking performance. Packaged in bike sets of 2 pairs and clips.



EVRS811

Compatibility:

Shimano Deore BR-M515, M475, M525, M465, M495. Tektro Draco, Dorado, Orion, Auriga, Aquilla. TRP Spyre, Hylex. Clarks HD-M3000, Clout, e-Clout, M2 (F and O), CMD-23/27

Part Number: EVRS811



EVRS852

Compatibility:

New XTR M985, M987, M988, M975, M965 - XT M785 - SLX M666, M675 - Deore M615. S700, S700 Alfine, R785 Clarks, M1, M2 (L) M3, CMD-22/22FM, CHM-8

Part Number: EVRS852



EVRS858

Compatibility:

Shimano XT 755-56. Avid Code (2011 onwards) Code-R.

Part Number: EVRS858



EVRS859

Compatibility:

Avid XO, Elixir 7 Trail, Elixir 9 Trail. SRAM Guide.

Part Number: EVRS859



EVRS863

Compatibility:

Tektro Dorado

Part Number: EVRS863

E-BIKE ■ ERGONOMIC GRIPS



CE-212

- Comfortable main body, 130mm
- Ergonomic design for increased comfort
- Integrated double alloy lock clamp 100% non-slip

Black
CE-212-BLACK



CS-002

- Ergonomic design for increased comfort
- Silicone grips have the ability to adapt to the shape of your palm providing unrivalled support & control
- 100% Non-slip single locking rings for secure fitment

Black
CS-002



CE-242

- Ergonomic grip with good palm support and grooved grip pattern.
- Integrated single side locking rings
- Thermo-plastic resin
- Length 140mm

Black
CE-242-BLACK



CL-301

- Two tone ergonomic grip with good palm support.
- Thermo-plastic resin
- Length 135mm

Black/Grey
CL-301

E-Bike Chains

- Nickel plated silver
- Low maintenance
- Compatible with mid motor E-bikes, Bosch & other major E-bike systems

Speeds

Single, 5-7, 8, 9, 10, 11 and 12

Part Numbers

Speed	Part Number	Speed	Part Number
Single	C-C410E	10	C-C10E
5-7	C-C5-7E	11	C-C11E
8	C-C8E	12	C-C12E
9	C-C9E		



Hydraulic disc brakes
4-17

Mechanical disc brakes
18-23

Disc pads
24-29

Rotors
30-35

Calliper brackets
36-39

V-Brakes
40-43

Brake pads & cartridges
44-49

Cable kits & wires
50-57

Cassettes
59

Chains & accessories
60-61

Chainrings
62-63

Bottom brackets
64

Gears
65

Grips
66-75

E-Bike
76-77

Headsets
78-79

Hydraulics
80-87

Service - trays
88-89

Service - Wire, cable & hose
90-91

Service - Parts
92-94

Bottle Cages
95



HEADSETS

Our range of headsets covers basic entry level to high end. We have also incorporated all major sizes. The headsets have been constructed from the highest grade of materials which guarantees a high quality finish and a product that is both strong and durable. We have paid special attention to the bearings to ensure they are of the best quality so that the operation of the headset is smooth and provides longevity to every rider.



ALLOY



PRECISION
ENGINEERED



MAINTENANCE
FREE



SERVICE & REPAIR PARTS

clarks.bike/order-spare-parts.html



SERVICE & FITTING VIDEOS

clarks.bike/how-to-videos.html



PRODUCT HELPLINE info@clarks.bike

+44 (0)1455 254800

HEADSETS



Semi Integrated Steel - cartridge bearings

1-1/8" Threadless headset. Steel construction with cartridge bearings.

- Stack Height - 9.8mm
- Weight - 57g
- Dimensions - 1-1/8" x 30 x 34
- Steel
- Compatibility - MTB/Road

Part Number: CH-115



Semi Integrated Steel - cartridge bearings

1-1/8" Threadless headset. Steel construction with cartridge bearings.

- Stack Height - 23.6mm
- Weight - 113g
- Dimensions - 1-1/8" x 30 x 34
- Steel
- Compatibility - MTB/Road

Part Number: CH-115-1



Semi Integrated Alloy - sealed bearings

1-1/8" Threadless headset. Alloy construction with sealed bearings.

- Stack Height - 29mm
- Weight - 102g
- Dimensions - 1-1/8" x 30 x 34
- 6061 Alloy CNC Machined
- Compatibility - MTB

Part Number: CH-773



Semi Integrated Steel - sealed bearings

1-1/8" Threadless headset. Steel construction with sealed bearings.

- Stack Height - 28mm
- Weight - 127g
- Dimensions - 1-1/8" x 30 x 34
- Steel
- Compatibility - MTB

Part Number: CH-845



Semi Integrated Steel - sealed bearings

1-1/8" Threadless headset. Steel construction with sealed bearings.

- Stack Height - 28mm
- Weight - 127g
- Dimensions - 1-1/8" x 30 x 34
- Steel
- Compatibility - MTB

Part Number: CH-852



Semi Integrated Alloy - sealed bearings

1-1/8" Threadless headset. Alloy construction with sealed bearings.

- Stack Height - 22mm
- Weight - 105g
- Dimensions - 1-1/8" x 30 x 34
- Alloy
- Compatibility - MTB

Part Number: CH-867



Integrated Alloy - sealed bearings

1-1/8" Threadless headset. Alloy construction with sealed bearings.

- Stack Height - 9.7mm
- Weight - 75g
- Dimensions - 1-1/8" x 41.8 x 30
- Aluminium
- Compatibility - MTB/Road

Part Number: CH-53



Integrated Alloy - sealed bearings

1-1/8" Threadless headset. Alloy construction with sealed bearings.

- Stack Height - 10mm
- Weight - 61g
- Dimensions - 1-1/8" x 44/50 x 30
- 6061 Alloy CNC Machined
- Compatibility - Road

Part Number: CH-125



Integrated Steel & Alloy - cartridge bearings

1-1/8" to 1-1/2" Threadless headset. Alloy construction with cartridge bearings.

- Stack Height - 9.5mm
- Weight - 155g
- Dimensions - 1-1/8" to 1-1/2" x 44-56 x 30 /39.8
- Steel and Aluminium
- Compatibility - MTB/Road

Part Number: CH-190



Integrated Alloy - sealed bearings

1-1/8" to 1-1/2" Threadless headset. Alloy construction with sealed bearings

- Stack Height - 13.8mm
- Weight - 140g
- Dimensions - 1-1/8" to 1-1/2" x 44-46 x 30/39.8
- Aluminium
- Compatibility - MTB/Road

Part Number: CH-202M



Integrated Alloy - sealed bearings

1-1/8" to 1-1/2" Threadless headset. Alloy construction with sealed bearings

- Stack Height - 10mm
- Weight - 110g
- Dimensions - 1-1/8" to 1-1/2" x 41.8-52 x 30/39.8
- Aluminium
- Compatibility - MTB/Road

Part Number: CH-532



Integrated Steel & Alloy - cartridge bearings

1-1/8" to 1-1/2" Threadless headset. Alloy construction with cartridge bearings.

- Stack Height - 9.5mm
- Weight - 195g
- Dimensions - 1-1/8" to 1-1/2" x 44-56 x 30 /39.8
- Steel and Aluminium
- Compatibility - MTB/Road

Part Number: CH-830

Hydraulic disc brakes
4-17

Mechanical disc brakes
18-23

Disc pads
24-29

Rotors
30-35

Calliper brackets
36-39

V-Brakes
40-43

Brake pads & cartridges
44-49

Cable kits & wires
50-57

Cassettes
59

Chains & accessories
60-61

Chainrings
62-63

Bottom brackets
64

Gears
65

Grips
66-75

E-Bike
76-77

Headsets
78-79

Hydraulics
80-87

Service - trays
88-89

Service - Wire, cable & hose
90-91

Service - Parts
92-94

Bottle Cages
95



HYDRAULICS

Clarks expertise across all aspects of brake related cycle products have allowed us put together a comprehensive range of parts for the hydraulic brake servicing workshop. We have worked with teams of cycle mechanics to create a range of products that minimise service time and increase profit margins.



SERVICE & REPAIR PARTS

clarks.bike/order-spare-parts.html



SERVICE & FITTING VIDEOS

clarks.bike/how-to-videos.html



PRODUCT HELPLINE
info@clarks.bike

+44 (0)1455 254800

Hydraulic disc brakes
4-17

Mechanical disc brakes
18-23

Disc pads
24-29

Rotors
30-35

Calliper brackets
36-39

V-Brakes
40-43

Brake pads & cartridges
44-49

Cable kits & wires
50-57

Cassettes
59

Chains & accessories
60-61

Chainrings
62-63

Bottom brackets
64

Gears
65

Grips
66-75

E-Bike
76-77

Headsets
78-79

Hydraulics
80-87

Service - trays
88-89

Service - Wire, cable & hose
90-91

Service - Parts
92-94

Bottle Cages
95

HYDRAULIC BRAKE SYSTEM BLEED PROCEDURE TIPS

- Remove pads to avoid fluid contamination
- Push fluid from calliper to lever
- Rest to allow pressure to even out
- Disconnect calliper syringe first
- Always test brakes before use

Clarks brake systems only use mineral oil, in order to protect the environment



MTB



HYBRID



E-BIKE



ROAD

CLARKS

HYDRAULICS ■ BLEED KITS

Clarks universal bleed kits have been developed in conjunction with cycle mechanics using a number of different manufacturers' brake systems to ensure they are fit for purpose. They offer superb value for money while maintaining the highest quality of components. All our bleed kits are supplied with Stainless steel bleed nipples and seals to ensure a perfect tight fit and longevity of the components. The kit also has turn lock syringes and tubing to prevent blow off when under pressure. Also all bleed tubing has individual lock out clips to prevent air pull backs. Such features reduce bleeding time and ensure a perfectly bled brake each and every time.

Universal Bleed Kit

This bleed kit is the only bleed kit a workshop would need, it contains all tools needed to bleed the majority of brakes available on the market today such as Avid, Hayes, Magura, Clarks, Shimano, Tektro, Hope, Formula & More.

Contents

Description	Qty
Turn-Lock syringes	2
Standard syringes	2
Bleed adapters with lock out feature	8
Velcro tie	1
Pair of latex gloves	1
Bleed block	2
Rubber 'O' rings	10
1mm Allen key	1
2mm Allen key	1
Torx head wrench	1



Part Number: UNI-BLEED

Avid Bleed Kit

Avid compatible bleed kit.

Contents

Description	Qty
Turn-Lock syringes	2
Bleed adapters with lock out feature	2
Velcro tie	1
Pair of latex gloves	1
Bleed block	1
Rubber 'O' rings	10



Part Number: AVI-BLEED

Tektro Bleed Kit

Tektro compatible bleed kit.

Contents

Description	Qty
Turn-Lock syringes	2
Bleed adapters with lock out feature	2
Velcro tie	1
Pair of latex gloves	1
Bleed block	1
Rubber 'O' rings	10



Part Number: TEK-BLEED

Shimano Bleed Kit

Shimano compatible bleed kit.

Contents

Description	Qty
Turn-Lock syringes	2
Bleed adapters with lock out feature	3
Velcro tie	1
Pair of latex gloves	1
Bleed block	1
Rubber 'O' rings	10



Part Number: SHI-BLEED

Clarks M2 Bleed Kit

Clarks M2 specific bleed kit, designed to bleed and maintain Clarks M2 brake only.

Contents

Description	Qty
Turn-Lock syringes	2
Bleed adapters with lock out feature	2
Pair of latex gloves	1

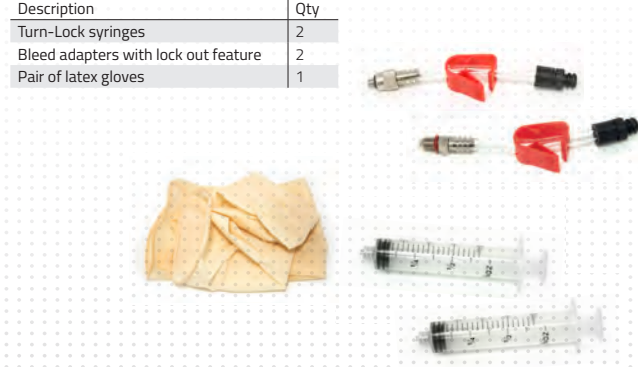

Part Number: M2-BLEED

Hydraulic disc brakes
4-17

Mechanical disc brakes
18-23

Disc pads
24-29

Rotors
30-35

Calliper brackets
36-39

V-Brakes
40-43

Brake pads & cartridges
44-49

Cable kits & wires
50-57

Cassettes
59

Chains & accessories
60-61

Chainrings
62-63

Bottom brackets
64

Gears
65

Grips
66-75

E-Bike
76-77

Headsets
78-79

Hydraulics
80-87

Service - trays
88-89

Service - Wire, cable & hose
90-91

Service - Parts
92-94

Bottle Cages
95

HYDRAULICS ■ HOSES

Clarks Hoses are manufactured from the most advanced materials available. Double jacketed Kevlar® fibres over a braided PVDF Polymer underlay, with spiral fibre wrap reinforcement, creates a superior hose with great strength, resistant to impact and expansion. Our hoses are compatible with all major brands, and available in a range of colours.

Hose Dispenser Boxes

Each dispenser box is constructed of highly durable card and contains 30 meters of hose wrapped around a central wheel so that they can be easily decanted from the box and cut to size.

- 30 meters of hose
- Highly durable dispenser

Options available:

Part Numbers:	Compatibility:	Outer	Inner dia.
HH1-30M	Clarks (M4, Skeletal, Exo, S2) Shimano	5mm	2.3mm
HH2-30M	Avid, Magura, Formula, Clarks (Clout, M1, M2, M3, HDM3000)	5mm	2.0mm

Hose Kits

All hose kits are supplied with 3000mm length of hose (that can be cut to size) to change both front and rear brake lines. All necessary fittings for front and rear callipers and levers.

- 3000mm Length hose
- All fittings included for front and rear callipers
- All hoses are black

Taiwan

Options available:

Part Numbers:	Brand Compatibility	Model Compatibility:
HH3-1-BLK	Avid	Juicy 5/7, Juicy Carbon, Ultimate
HH3-2-BLK	Avid	Juicy 3, Code
HH3-3-BLK	Avid	Elixir, CR, XX, XO
HH1-1-BLK	Clarks	Skeletal, Exo, HDB-540, HDB-600, HDB-790
C-HH1-1-BLK	Clarks	M4 (Shimano Compatible)
HH5-1-BLK	Formula	Oro
HH4-1-BLK	Hayes	Stroker Ryde
HH4-2-BLK	Hayes	Stroker Trail, Ace, Gram, Camino, Prime
HH2-1-BLK	Magura	Marta, Louise, MT
HH1-1-BLK	Shimano	XTR 2007-9, TX 2008-9, LX 2005-8, Deore 2005-9
HH1-2-BLK	Shimano	XTR 2005-6
HH1-3-BLK	Shimano	Deore XT 2005-7

Mineral Oil

To support our range of brakes and bleed kits we have introduced mineral oil, recommended for use with Clarks hydraulic brake systems. Supplied in a 125ml bottle with a child proof cap.

- Long shelf life
- Non-corrosive
- Less harmful to the environment than dot fluids

Part Numbers:

Description	Part Number
125ml Bottle	MIN-OIL-1

Calliper & Lever End Fittings

Clarks supply shimano compatible lever end and calliper end fittings in consumer friendly blister packs.

Taiwan

Part Numbers:

Description	Compatibility	Part Number
Calliper end fitting	Shimano	HF-C1F
Lever end fitting	Shimano	HF-L1F



Hydraulic disc brakes
4-17

Mechanical disc brakes
18-23

Disc pads
24-29

Rotors
30-35

Calliper brackets
36-39

V-Brakes
40-43

Brake pads & cartridges
44-49

Cable kits & wires
50-57

Cassettes
59

Chains & accessories
60-61

Chainrings
62-63

Bottom brackets
64

Gears
65

Grips
66-75

E-Bike
76-77

Headsets
78-79

Hydraulics
80-87

Service - trays
88-89

Service - Wire, cable & hose
90-91

Service - Parts
92-94

Bottle Cages
95

HYDRAULICS ■ FITTINGS TRAY & REFILL PACKS

Fittings Tray

The hydraulic fittings tray consists of a number of hydraulic fittings suitable for the following manufacturers brakes - Avid, Magura, Shimano, Tektro, Hayes and Formula. The tray has been developed to offer a cost effective way of replacing and maintaining hydraulic hose. Please note refills for the tray are available in bags of 10 pcs. Refer to compatibility table below.

Contents

Description	Qty
HFK-16 (Plastic cover)	8
HFK-18 (Compression Nut - Formula)	10
HFK-21 (Compression Nut - Magura)	10
HFK-06 (Compression Nut - Shimano)	10
HFK-26 (Compression Nut - Avid)	10
HFK-29 (Compression Nut - Hayes/Tektro)	10
HFK-31 (Shim)	10
HFK-19 (Olive - Formula)	10
HFK-22 (Olive - Magura)	10
HFK-24 (Olive - Shimano)	10
HFK-27 (Olive - Avid)	10
HFK-67 (Needle - Tektro)	10
HFK-05 (Oil Seal)	10
HFK-20 (Needle - Formula)	10
HFK-23 (Needle - Magura)	10
HFK-25 (Needle - Shimano)	10
HFK-28 (Needle - Avid)	10
HFK-66 (Olive - Tektro)	10



Part Number: HYD-02 (see also page 85)

Service Refill Packs

Clark's hydraulic fittings are designed to service all major brake systems on the market. They are constructed from high-grade materials to ensure high quality and longevity of fittings. Calliper and lever end fittings are all re-usable. All fittings are supplied 10 pre pack.



Compression Nut
Compatibility -
Avid (M8 - 0.75)

Finish	Part No:
Plain	HFK-26



Compression Nut
Compatibility -
Formula (M8 - 1mm)

Finish	Part No:
Plain	HFK-18



Compression Nut
Compatibility -
Hayes/Tektro (M8 - 0.75)

Finish	Part No:
Plain	HFK-29



Compression Nut
Compatibility -
Magura (M9 - 1.25)

Finish	Part No:
Plain	HFK-21



Compression Nut
Compatibility -
Shimano (M8 - 0.75)

Finish	Part No:
Plain	HFK-06



Olive
Compatibility -
Avid (5mm)

Finish	Part No:
Plain	HFK-27



Olive
Compatibility -
Formula (5mm)

Finish	Part No:
Plain	HFK-19



Olive
Compatibility -
Tektro (5.5mm)

Finish	Part No:
Plain	HFK-66



Olive
Compatibility -
Magura (5mm)

Finish	Part No:
Plain	HFK-22



Needle
Compatibility -
Shimano (5mm)

Finish	Part No:
Plain	HFK-24



Needle
Compatibility -
Avid (2.35/2.4mm)

Finish	Part No:
Plain	HFK-28



Needle
Compatibility -
Formula (2.1mm)

Finish	Part No:
Plain	HFK-20



Needle
Compatibility -
Tektro (2.5mm)

Finish	Part No:
Plain	HFK-67



Needle
Compatibility -
Magura (2.45/2.5mm)

Finish	Part No:
Plain	HFK-23



Needle
Compatibility -
Shimano (2.3mm)

Finish	Part No:
Plain	HFK-25



Oil seal
Compatibility -
1mm copper

Finish	Part No:
Plain	HFK-05



Shim
Compatibility -
0.2mm

Finish	Part No:
Plain	HFK-31



Plastic Cover

Finish	Part No:
Plain	HFK-16

Hydraulic Spare Parts Trays

To support mechanics and cycle workshops vital for maintaining Clarks hydraulic brakes, we offer a workshop tray of essential spare parts, specific to the Clout, M2 and M4. Presented in a re-usable, clear plastic tray. All parts can be purchased in the quantities shown below to replenish the tray.



Hydraulic disc brakes
4-17

Mechanical disc brakes
18-23

Disc pads
24-29

Rotors
30-35

Calliper brackets
36-39

V-Brakes
40-43

Brake pads & cartridges
44-49

Cable kits & wires
50-57

Cassettes
59

Chains & accessories
60-61

Chainrings
62-63

Bottom brackets
64

Gears
65

Grips
66-75

E-Bike
76-77

Headsets
78-79

Hydraulics
80-87

Service - trays
88-89

Service - Wire, cable & hose
90-91

Service - Parts
92-94

Bottle Cages
95

Clout Parts Tray

Part No:
CLOUT-SERV-B-22

M2 (L) Parts Tray

Part No:
M2-SERV-L-22

M2 (F & O) Parts Tray

Part No:
M2-SERV-B-22

M4 Parts Tray

Part No:
M4-SERV-L-22

Tray Contents

Clout Hydraulic Brake set parts

Description:	Part Number:	Quantity:
Calliper Piston Seal	X-PS-1-B	80
Lever Piston Circlip	X-PCC-1-B	40
Calliper Piston	X-CP-1-B	80
Lever Bleed Bolt	X-LBB-1-B	40
C-jet Lever Plug	X-CJET-LP-1-B	40
Rubber Boot	X-RB-1-B	80
Lever Plunger	X-LP-1-X	40
Disc Pad Retaining Bolt	X-DPRB-1-X	40
Olive and Insert	X-OL-1-X	80 Sets
Compression Nut	X-CN-1-B	80
Lever Blade	X-2FLB-1-B	40
Reservoir Diaphragm Right	X-RD-1-X	20
Reservoir Diaphragm Left	X-DL-1-X	20
Reservoir Cover Right	X-RCR-1-X	20
Reservoir Cover Left	X-RCL-1-X	20
Calliper Bolt M6X16	X-CB-1-X	80
Calliper Bolt M6x18	X-M6X18-X	80
Calliper Bolt M6x20	X-M6X20-X	80
Lever Clamp Bolt	X-LHBCB-1-X	40

Tray Contents

M2 (Serial L) Hydraulic Brake set parts

Description:	Part Number:	Quantity:
Calliper Piston Seal	X-PS-1-B	80
Lever Piston Circlip	X-PCC-1-B	40
Calliper Piston	X-CP-1-B	80
Lever Bleed Bolt	X-LBB-1-B	40
C-jet Lever Plug	X-CJET-LP-1-B	40
Rubber Boot	X-RB-1-B	80
Disc Pad Retaining Bolt	X-DPRB-1-X	40
Olive and Insert	X-OL-1-X	80 Sets
Compression Nut	X-CN-1-B	80
Lever Blade	X-2FLB-1-B	40
Reservoir Diaphragm Right	X-RD-1-X	20
Reservoir Diaphragm Left	X-DL-1-X	20
Reservoir Cover Right	X-RCR-1-X	20
Reservoir Cover Right	X-RCL-1-X	20
Calliper Bolt M6X16	X-CB-1-X	80
Calliper Bolt M6x18	X-M6X18-X	80
Calliper Bolt M6x20	X-M6X20-X	80
Lever Clamp Bolt	X-LHBCB-1-X	40

Tray Contents

M2 (Serial F & O) Hydraulic Brake set parts

Description:	Part Number:	Quantity:
Calliper Piston Seal	X-PS-1-B	80
Lever Piston Circlip	X-PCC-1-B	40
Calliper Piston	X-CP-1-B	80
Lever Bleed Bolt	X-LBB-1-B	40
C-jet Lever Plug	X-CJET-LP-1-B	40
Rubber Boot	X-RB-1-B	80
Disc Pad Retaining Bolt	X-DPRB-1-X	40
Olive and Insert	X-OL-1-X	80 Sets
Compression Nut	X-CN-1-B	80
Lever Blade	X-2FLB-1-B	40
Reservoir Diaphragm Right	X-RD-1-X	20
Reservoir Diaphragm Left	X-DL-1-X	20
Reservoir Cover Right	X-RCR-1-X	20
Reservoir Cover Right	X-RCL-1-X	20
Calliper Bolt M6X16	X-CB-1-X	80
Calliper Bolt M6x18	X-M6X18-X	80
Calliper Bolt M6x20	X-M6X20-X	80
Lever Clamp Bolt	X-LHBCB-1-X	40

Tray Contents

M4 Hydraulic Brake set parts























Description:	Part Number:	Quantity:
Calliper Piston Seal	M4-PS-1	80
Lever Piston Circlip	X-PCC-1-B	40
Calliper Piston	M4-CP-1	80
Lever Bleed Bolt	BL-M4-012	40
C-jet Lever Plug	M4-LP-1-L	40
Lever Piston Seal	M4-PS-2	40 Sets
Disc Pad Retaining Bolt	X-DPRB-1-X	40
Olive and Insert	M-OL-1	80 Sets
Compression Nut	X-CN-1-B	40
Lever Return Spring	X-LPRS-1-X	80
Lever Blade	M4-LB-1	40
Lever Clamp	M4-LCLA-1	40
Lever Clamp Bolt	X-LHBCB-1-X	40
Lever Plunger	X-LP-1-X	40
Calliper Bolt M6x16	X-M6X18-X	80
Calliper Bolt M6x18	X-M6X20-X	80
Calliper Bolt M6x20	X-LHBCB-1-X	80

HYDRAULICS ■ FITTINGS - CLARKS HYDRAULIC BRAKE SPARE PARTS

Shared Parts

All of the parts below are common to the following brake sets:
Clout, E-Clout, Clout1 Plus, M2, M4 and HD-M3000



















- Hydraulic disc brakes 4-17
- Mechanical disc brakes 18-23
- Disc pads 24-29
- Rotors 30-35
- Calliper brackets 36-39
- V-Brakes 40-43
- Brake pads & cartridges 44-49
- Cable kits & wires 50-57
- Cassettes 59
- Chains & accessories 60-61
- Chainrings 62-63
- Bottom brackets 64
- Gears 65
- Grips 66-75
- E-Bike 76-77
- Headsets 78-79
- Hydraulics 80-87
- Service - trays 88-89
- Service - Wire, cable & hose 90-91
- Service - Parts 92-94
- Bottle Cages 95

				
Calliper piston seal	Lever piston circlip	Calliper piston 22mm - Nylon	Calliper bleed bolt with seal	Lever bleed bolt with seal
Part No: X-PS-1-B	Part No: X-PCC-1-B	Part No: X-CP-1-B	Part No: X-CBB-1-B	Part No: X-LBB-1-B
Brake Models: M2 E-CLOUT CLOUT PLUS HD-M3000	Brake Models: M2 M4 CLOUT E-CLOUT CLOUT PLUS HD-M3000	Brake Models: M2 E-CLOUT CLOUT PLUS HD-M3000	Brake Models: M2 CLOUT E-CLOUT CLOUT PLUS HD-M3000	Brake Models: M2 CLOUT E-CLOUT CLOUT PLUS HD-M3000
				
Rubber boot	Olive and Insert	Compression Nut	Disc pad retaining bolt	Reservoir diaphragm Left
Part No: X-RB-1-B	Part No: X-OL-1-X	Part No: X-CN-1-B	Part No: X-DPRB-1-X	Part No: X-DL-1-X
Brake Models: M2 M4 CLOUT E-CLOUT CLOUT PLUS HD-M3000	Brake Models: M2 CLOUT E-CLOUT CLOUT PLUS HD-M3000	Brake Models: M2 M4 CLOUT E-CLOUT CLOUT PLUS HD-M3000	Brake Models: M2 M4 CLOUT E-CLOUT CLOUT PLUS HD-M3000	Brake Models: M2 CLOUT E-CLOUT CLOUT PLUS
				
Reservoir diaphragm Right	Reservoir cover Left	Reservoir cover Right	Lever blade (2 Finger)	Lever blade (3 Finger)
Part No: X-DR-1-X	Part No: X-RCL-1-X	Part No: X-RCR-1-X	Part No: X-2FLB-1-B	Part No: X-3FLB-1B
Brake Models: M2 CLOUT E-CLOUT CLOUT PLUS	Brake Models: M2 CLOUT E-CLOUT CLOUT PLUS	Brake Models: M2 CLOUT E-CLOUT CLOUT PLUS	Brake Models: M2 CLOUT	Brake Models: E-CLOUT CLOUT PLUS HD-M3000
				
Lever return spring	Lever plunger	Lever piston seals Outer dia. 10.2mm Inner dia. 4mm / 6mm	Calliper bracket fixing bolt M6x16mm	Calliper bracket fixing bolt M6x18mm
Part No: X-LPRS-1-X	Part No: X-LP-1-X	Part No: X-LPS-1-X	Part No: X-CB-1-X	Part No: X-M6X18-X
Brake Models: M2 M4 CLOUT E-CLOUT CLOUT PLUS HD-M3000	Brake Models: M2 M4 CLOUT E-CLOUT CLOUT PLUS HD-M3000	Brake Models: M2 CLOUT E-CLOUT CLOUT PLUS HD-M3000	Brake Models: M2 M4 CLOUT E-CLOUT CLOUT PLUS HD-M3000	Brake Models: M2 M4 CLOUT E-CLOUT CLOUT PLUS HD-M3000
				
Calliper bracket fixing bolt M6x20mm	Lever handle bar clamp bolt M6x19mm	C-Jet Plug		
Part No: X-M6X20-X	Part No: X-LHBCB-1-X	Part No: X-CJET-LP-1-B		
Brake Models: M2 M4 CLOUT E-CLOUT CLOUT PLUS HD-M3000	Brake Models: M2 M4 CLOUT E-CLOUT CLOUT PLUS HD-M3000	Brake Models: M2 CLOUT E-CLOUT CLOUT PLUS HD-M3000		

HYDRAULICS ■ FITTINGS - CLARKS HYDRAULIC BRAKE SPARE PARTS



Model Specific Parts

The parts below are specific to M4, Clout1 and HD-M300 models as indicated.

 <p>Reservoir diaphragm Left</p> <p>Part No: BL-3000-08</p> <p>Brake Models: HD-M3000</p>	 <p>Reservoir diaphragm Left</p> <p>Part No: BL-3000-07</p> <p>Brake Models: HD-M3000</p>	 <p>Reservoir cover Left</p> <p>Part No: BL-3000-041</p> <p>Brake Models: HD-M3000</p>	 <p>Reservoir cover Right</p> <p>Part No: BL-3000-042</p> <p>Brake Models: HD-M3000</p>	 <p>Sensor cable retention grub screw</p> <p>Part No: BL-3000-043</p> <p>Brake Models: HD-M3000</p>
 <p>Sensor cable - Male Juliette</p> <p>Part No: BL-3000-04</p> <p>Brake Models: HD-M3000</p>	 <p>Calliper piston seal</p> <p>Part No: M4-PS-1</p> <p>Brake Models: M4</p>	 <p>Lever piston seal</p> <p>Part No: M4-PS-2</p> <p>Brake Models: M4</p>	 <p>Calliper piston</p> <p>Part No: M4-CP-1</p> <p>Brake Models: M4</p>	 <p>Calliper bleed bolt with seal</p> <p>Part No: BL-M-025</p> <p>Brake Models: M4</p>
 <p>Lever bleed bolt with seal</p> <p>Part No: BL-M4-012</p> <p>Brake Models: M4</p>	 <p>Olive and insert</p> <p>Part No: M4-OL-1</p> <p>Brake Models: M4</p>	 <p>Lever blade (2 Finger)</p> <p>Part No: M4-LB-1</p> <p>Brake Models: M4</p>	 <p>Lever clamp</p> <p>Part No: M4-LCLA-1</p> <p>Brake Models: M4</p>	 <p>Reservoir diaphragm left or right</p> <p>Part No: BL-M4-003</p> <p>Brake Models: M4</p>
 <p>C-Jet Plug</p> <p>Part No: M4-LP-1-L</p> <p>Brake Models: M4</p>	 <p>Calliper piston seal</p> <p>Part No: BL-M1-020B</p> <p>Brake Models: CLOUT</p>	 <p>Calliper piston</p> <p>Part No: BL-M1-021-B</p> <p>Brake Models: CLOUT</p>		

Consumer Packs

Clarks supplies lever end and calliper end fittings for Clarks M1, M2 and M3 Hydraulic brakes.

 <p>Hose Reduction Kit Compatibility - Clarks Clout, M1, all M2, M3 & M4 Part Number: M2-CL</p>	 <p>Olive & Insert Compatibility - Clarks Clout, M1, all M2, M3 & M4 Part Number: M2-OL-1</p>	 <p>Seal Replacement Kit All the internal seals. 1 kit per brake. Compatibility - Clarks M2 (all versions) Part Number: M2-SK-01</p>
--	--	---

- Hydraulic disc brakes 4-17
- Mechanical disc brakes 18-23
- Disc pads 24-29
- Rotors 30-35
- Calliper brackets 36-39
- V-Brakes 40-43
- Brake pads & cartridges 44-49
- Cable kits & wires 50-57
- Cassettes 59
- Chains & accessories 60-61
- Chainrings 62-63
- Bottom brackets 64
- Gears 65
- Grips 66-75
- E-Bike 76-77
- Headsets 78-79
- Hydraulics 80-87
- Service - trays 88-89
- Service - Wire, cable & hose 90-91
- Service - Parts 92-94
- Bottle Cages 95



SERVICE PARTS

We have a wide range of high quality service parts to support all workshops, they are the perfect balance between value for money and exceptional quality, all our workshop packaging has been specifically designed to be highly durable and use space as effectively as possible within the workshop.



LIGHTWEIGHT



ALLOY



DIE DRAWN



TORX HEAD



SERVICE & REPAIR PARTS

clarks.bike/order-spare-parts.html



SERVICE & FITTING VIDEOS

clarks.bike/how-to-videos.html



PRODUCT HELPLINE
info@clarks.bike

+44 (0)1455 254800

SERVICE ■ SERVICE TRAYS

Workshop Fittings Tray

Clarks workshop fitting component tray carries commonly used parts for both cable operated brakes and gear systems. Components include, ferrules, for brake and gear, 'O' rings, guide pipes and rubber boots for V-brakes. All presented in a sturdy re-usable clear plastic tray, with dividers that create sized compartments.

Contents

Description	Qty
CX15 (Brass ferrule)	400
CX88 (Wire end cover)	500
CX25 (Rubber boot)	80
CX103 (Gear 'O' ring)	100
CX102 (Brake 'O' ring)	100
CX20 (4mm Ferrule)	450
CX24 (135 degree bend guide pipe)	40
CX23 (90 degree bend guide pipe)	40

Part Number: TRAY-02



Hydraulic Fittings Tray

The hydraulic fittings tray consists of a number of hydraulic fittings suitable for the following manufacturers brakes - Avid, Magura, Shimano, Tektro, Hayes and Formula. The tray has been developed to offer a cost effective way of replacing and maintaining hydraulic hose. Please note refills for the tray are available in bags of 10 pcs (Page 80). Refer to compatibility table below.

Contents

Description	Qty	Description	Qty
HFK-16 (Plastic cover)	8	HFK-24 (Olive - Shimano)	10
HFK-18 (Gland Nut - Formula)	10	HFK-27 (Olive - Avid)	10
HFK-21 (Gland Nut - Magura)	10	HFK-67 (Needle - Tektro)	10
HFK-06 (Gland Nut - Shimano)	10	HFK-05 (Oil Seal)	10
HFK-26 (Gland Nut - Avid)	10	HFK-20 (Needle - Formula)	10
HFK-29 (Gland Nut - Tektro/Hayes)	10	HFK-23 (Needle - Magura)	10
HFK-31 (Shim)	10	HFK-25 (Needle - Shimano)	10
HFK-19 (Olive - Formula)	10	HFK-28 (Needle - Avid)	10
HFK-22 (Olive - Magura)	10	HFK-66 (Olive - Tektro)	10

Part Number: HYD-02



Disc Pad Pin Tray

The disc pad pin tray offers a variety of replacement Pins that retain the disc pads for all leading brakes in the market. All pins are made of stainless steel and quality of construction can easily match and exceed the standard OEM pins supplied.

Contents

Description	Qty
M4 x 22.5mm socket screw (Magura, Marta, Louise Gustava 2007)	10
35mm Fixing pin (Shimano Deore, Avid Elixir)	30
45mm Fixing pin (Hayes, Hope)	10
M4 x 22mm Fixing bolt (Avid Elixir 5, 7, 9, Guide, Code, Trail)	20
M4 x 27mm Fixing bolt (Shimano XT/XTR, Magura MT 2, 4, 6, 8, Tektro, Formula Oro)	20
M4 x 36mm Fixing bolt (Hayes Ryde, Dyno)	10
M5 x 25mm Fixing bolt (Formula Mega, Hope E4, V4, X2, V2)	10
Clips for M4/M5 fixing bolts	10

Part Number: CDPT-01



Hydraulic disc brakes
4-17

Mechanical disc brakes
18-23

Disc pads
24-29

Rotors
30-35

Calliper brackets
36-39

V-Brakes
40-43

Brake pads & cartridges
44-49

Cable kits & wires
50-57

Cassettes
59

Chains & accessories
60-61

Chainrings
62-63

Bottom brackets
64

Gears
65

Grips
66-75

E-Bike
76-77

Headsets
78-79

Hydraulics
80-87

Service - trays
88-89

Service - Wire, cable & hose
90-91

Service - Parts
92-94

Bottle Cages
95

SERVICE ■ WORKSHOP DISPENSER BOXES

Clarks can provide workshops with dispenser boxes that make bicycle servicing easier and faster. We can supply all our best selling cables and wires in bulk, contained within a hard wearing robust box. Wires and cables are kept clean and contamination free, whilst still remaining easy to access when required.



Die Drawn Wires

Die Drawn wires offer greatly reduced friction between the wire and liner. Drawn wires perform better than any other control cables on the market today.

The reduced friction is achieved by micro hammering the surface of the wire to the preferred diameter, this is then inserted into a drawing die and pulled through the draw plate multiple times, further 'flattening' the profile of the wire to achieve a continuously smooth surface.

19 Strand stainless steel wire



19 Strand die drawn steel wire

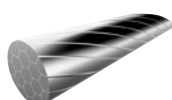

Wire - PTFE Coated

PTFE coated gear wires.

- 1.1mm or 1.2mm diameter
- 100 wires per dispenser box
- Gear wire - 2275mm long

Part Numbers:

Description	Diameter	Compatibility	Nipple type	Part Number
Gear Wire	1.1mm	MTB/Hybrid/Road	Tube Nipple	W6021DB
Gear Wire	1.2mm	MTB/Hybrid/Road	Tube Nipple	W6021DB-S

Wire - Pre Lubricated

Maintenance free pre-lubricated inner wires.

- 100 wires per dispenser box.
- Brake wire -2000mm long. Gear wire - 2275mm long

Part Numbers:

Description	Diameter	Compatibility	Nipple type	Part Number
Brake Wire	-	MTB/Hybrid	Barrel Nipple	W7136DB
Brake Wire	-	Road	Pear Nipple	W7138DB
Gear Wire	1.1mm	MTB/Hybrid/Road	Tube Nipple	W7139DB

Die Drawn Wire - Stainless

Long life, anti corrosion. Die drawn wires. 1.5mm dia. Extra smooth braking & Indexing.

- 100 wires per dispenser box.
- Brake wire -2000mm long. Gear wire - 2275mm long

Part Numbers:

Description	Compatibility	Nipple type	Part Number
Brake Wire	MTB / Hybrid	Barrel Nipple	W6053DBDD
Brake Wire	Road	Pear Nipple	W6052DBDD
Gear Wire	MTB / Hybrid / Road	Tube Nipple	W6082DBDD

Wire - Stainless Steel

Long life anti corrosion stainless steel inner wires.

- 100 wires per dispenser box.
- Gear wire 1.1mm or 1.2mm diameter
- Brake wire -2000mm long. Gear wire - 2275mm long

Part Numbers:

Description	Diameter	Compatibility	Nipple type	Part Number
Brake Wire	-	MTB/Hybrid	Barrel Nipple	W6053DB
Brake Wire	-	Road	Pear Nipple	W6052DB
Gear Wire	1.1mm	MTB/Hybrid/Road	Tube Nipple	W6082DB
Gear Wire	1.2mm	MTB/Hybrid/Road	Tube Nipple	W6082DB-S

Die Drawn Wire - Galvanised

Galvanised coated. Die drawn wires. 1.5mm dia. Extra smooth braking & Indexing.

- 100 wires per dispenser box.
- Brake wire -2000mm long. Gear wire - 2275mm long

Part Numbers:

Description	Compatibility	Nipple type	Part Number
Brake Wire	MTB / Hybrid	Barrel Nipple	BW5089DBDD
Brake Wire	Road	Pear Nipple	PW5089DBDD
Gear Wire	MTB / Hybrid / Road	Tube Nipple	W5056DBDD

Wire - Galvanised

Galvanised coated inner wires.

- 100 wires per dispenser box.
- Gear wire 1.1mm or 1.2mm diameter
- Brake wire -2000mm long. Gear wire - 2275mm long

Part Numbers:

Description	Diameter	Compatibility	Nipple type	Part Number
Brake Wire	-	MTB/Hybrid	Barrel Nipple	BW5089DB
Brake Wire	-	Road	Pear Nipple	PW5089DB
Gear Wire	1.1mm	MTB/Hybrid/Road	Tube Nipple	W5056DB
Gear Wire	1.2mm	MTB/Hybrid/Road	Tube Nipple	W5056DB-S

- Hydraulic disc brakes 4-17
- Mechanical disc brakes 18-23
- Disc pads 24-29
- Rotors 30-35
- Calliper brackets 36-39
- V-Brakes 40-43
- Brake pads & cartridges 44-49
- Cable kits & wires 50-57
- Cassettes 59
- Chains & accessories 60-61
- Chainrings 62-63
- Bottom brackets 64
- Gears 65
- Grips 66-75
- E-Bike 76-77
- Headsets 78-79
- Hydraulics 80-87
- Service - trays 88-89
- Service - Wire, cable & hose 90-91
- Service - Parts 92-94
- Bottle Cages 95

SERVICE ■ WORKSHOP DISPENSER BOXES



Housing

- 30 meters of housing wrapped around a central wheel
- Easily decanted from the box and cut to size.
- Length - 30 metres

Part Numbers:

Type	Product Type	Colour	Part Number
Brake Housing	Pre-Lube	Braided Silver	7138DB
Brake Housing	2P	Silver	Y1008DB
Brake Housing	2P	Black	Y1005DB
Brake Housing	2P	Blue	Y1005DB-BLUE
Brake Housing	2P	Orange	Y1005DB-ORANGE
Brake Housing	2P	Pink	Y1005DB-PINK
Brake Housing	2P	Red	Y1005DB-RED
Brake Housing	2P	White	Y1005DB-WHITE
Gear Housing	Braided Pre-Lube	Silver	7139DB
Gear Housing	SP4	Silver	IGOC4DBS
Gear Housing	SP4	Black	IGOC4DB
Gear Housing	SP4	Blue	IGOC4DB-BLUE
Gear Housing	SP4	Orange	IGOC4DB-ORANGE
Gear Housing	SP4	Pink	IGOC4DB-PINK
Gear Housing	SP4	Red	IGOC4DB-RED
Gear Housing	SP4	White	IGOC4DB-WHITE
Gear Housing	SP4	Braided Carbon	7143DB

Dispenser Tray

- Tray with 5 dispenser boxes
- Die Drawn Stainless Steel MTB/Hybrid brake wire
- Die Drawn Stainless Steel gear wire
- Stainless Steel Road brake wire
- Brake Housing
- Gear Housing

Contents:

Description	Compatibility	Nipple type	Part Number
Brake Wire	MTB / Hybrid	Barrel Nipple	W6053DBDD
Brake Wire	Road	Pear Nipple	W6052DBDD
Gear Wire	MTB / Hybrid / Road	Tube Nipple	W6082DBDD
Gear Housing	SP4 Black	-	IGOC4DB
Brake Housing	2P Black	-	Y1005DB

Part Number: CDDPROM17

Hydraulic disc brakes
4-17

Mechanical disc brakes
18-23

Disc pads
24-29

Rotors
30-35

Calliper brackets
36-39

V-Brakes
40-43

Brake pads & cartridges
44-49

Cable kits & wires
50-57

Cassettes
59

Chains & accessories
60-61

Chainrings
62-63

Bottom brackets
64

Gears
65

Grips
66-75

E-Bike
76-77

Headsets
78-79

Hydraulics
80-87

Service - trays
88-89

Service - Wire, cable & hose
90-91

Service - Parts
92-94

Bottle Cages
95

SERVICE ■ WORKSHOP SERVICE COMPONENTS

We have a wide range of high quality service parts to support all workshops, they are the perfect balance between value for money and exceptional quality. All components are packed in a Clarks branded header bag in the quantities indicated below.

- Hydraulic disc brakes 4-17
- Mechanical disc brakes 18-23
- Disc pads 24-29
- Rotors 30-35
- Calliper brackets 36-39
- V-Brakes 40-43
- Brake pads & cartridges 44-49
- Cable kits & wires 50-57
- Cassettes 59
- Chains & accessories 60-61
- Chainrings 62-63
- Bottom brackets 64
- Gears 65
- Grips 66-75
- E-Bike 76-77
- Headsets 78-79
- Hydraulics 80-87
- Service - trays 88-89
- Service - Wire, cable & hose 90-91
- Service - Parts 92-94
- Bottle Cages 95



Hydraulic Multi-tool

Easy to use, this high quality multi-tool will ensure a good clean cut of all hydraulic hoses every time. Easy to replace, cutter blades are available. The reversible needle driver can be removed and used to fit banjo fittings and compression nuts. Combined with the hose clamp insertion of hydraulic fittings into the hose is accurate and correct thereby reducing the risk of fluid leaks. In addition the cutter blade can be easily replaced when required, replacement blades are available separately. Suitable for all types of hydraulic hoses, this multi-tool is a cycle mechanics 3rd hand.

- Hose cutter, ensuring a clean cut
- Needle driver / banjo and compression nut tool
- Hose clamp
- Compatible with all hydraulic hoses
- Solid aluminium construction
- Replaceable cutting blade
- Replaceable needle driver

Description	Part No:
Hydraulic multi-tool	CT-HHMT-01-AM
Replacement cutting blade	CT-HHMT-01-B-AM
Replacement needle driver	CT-HHMT-01-ND-AM



Gloves

- Workshop Nitrile gloves
- Tough, skin tight for dexterity
- Supplied in boxes of 50
- **NONE LATEX**

Pack of:	Size	Part No:
50 Gloves	Medium	CG-BL-M
50 Gloves	Large	CG-BL-L
50 Gloves	Extra Large	CG-BL-XL



Flat Mount Bolts

All of the following bolts are made from steel then coated in DACROMET® to prevent corrosion. They can be used to secure flat mount brackets.

Pack of:	Size	Part No:
2 x Flat Mount Bolts	12mm	CMB-FM07
2 x Flat Mount Bolts	23mm	CMB-FM01
2 x Flat Mount Bolts	28mm	CMB-FM02
2 x Flat Mount Bolts	33mm	CMB-FM03
2 x Flat Mount Bolts	38mm	CMB-FM04
2 x Flat Mount Bolts	43mm	CMB-FM05
2 x Flat Mount Bolts	48mm	CMB-FM06



Anodised Rotor Bolts

- Anodised nickel plated steel construction
- T25 Torx head
- Packs of 6

Colour	Part No:
Blue	CRB-6-ANO-BLUE
Gold	CRB-6-ANO-GOLD
Green	CRB-6-ANO-GREEN
Orange	CRB-6-ANO-ORANGE
Red	CRB-6-ANO-RED

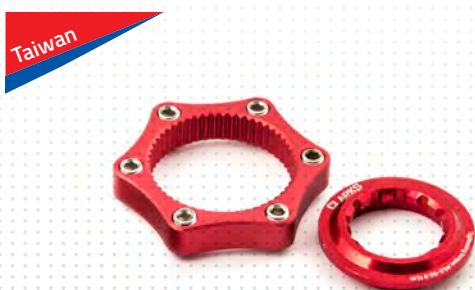

Centre Lock Adapter

- Clarks 6 bolt rotor to centre lock adapter.
- Easily and neatly adapts your 6-bolt rotors to fit on to centre-lock hubs
- Uses the proven centre-lock locking ring fixing system for quick and easy installation
- Manufactured from extremely strong 7075 Grade alloy

Pack of:	Part No:
1	CL-CLA

SERVICE ■ WORKSHOP SPARE COMPONENTS



A Headset Star Nut

- 1 x A headset star nut, 1"

Pack of:	Part No:
1	CHSN1-1PB



A Headset Star Nut

- 1 x A headset star nut, 1 1/8"

Pack of:	Part No:
1	CHSN118-1PB



A Headset Top Cap & Bolt

- 1x A head set top cap and bolt 1 1/8"

Pack of:	Part No:
1	C118HSC-1PB



A Headset Spacers

- 3 x A headset spacers 5mm x 1 1/8"

Pack of:	Part No:
3	CHSS118-3PB

Hydraulic disc brakes 4-17

Mechanical disc brakes 18-23

Disc pads 24-29

Rotors 30-35

Calliper brackets 36-39

V-Brakes 40-43

Brake pads & cartridges 44-49

Cable kits & wires 50-57

Cassettes 59

Chains & accessories 60-61

Chainrings 62-63

Bottom brackets 64

Gears 65

Grips 66-75

E-Bike 76-77

Headsets 78-79

Hydraulics 80-87

Service - trays 88-89

Service - Wire, cable & hose 90-91

Service - Parts 92-94

Bottle Cages 95



Bottle Cage Bolts

- 2 x M5 x 14mm Allen key bolts

Pack of:	Part No:
1	CBCB-2PB



Cable Ties & Clips

- Available in pots of 100

Pack of:	Part No:
3	CCGCT-3PB



Disc Brake Shims

- 10 x Disc brake shims 1.6mm x 2.08mm x 4mm.

Pack of:	Part No:
10	CS-10PB



Brake 'O' Rings

- 3 x Black brake 'O' rings

Pack of:	Part No:
3	CX102-3PB



C-Clip Cable Guides

- 3 x C-clip cable guides

Pack of:	Part No:
4	CCC-3PB



Gear Ferrules

- 10 x Steel gear ferrules

Pack of:	Part No:
10	CX18-10PB



Brake Ferrules

- 10 x Steel gear ferrules

Pack of:	Part No:
10	CX15-10PB



Gear 'O' Rings

- 3 x Gear 'O' rings

Pack of:	Part No:
3	CX103-3PB



Gear Ferrules

- 10 x Nylon gear ferrules - 4mm

Pack of:	Part No:
10	CX20-10PB



Wire End Covers

- 10 x Black wire end covers

Pack of:	Part No:
10	CX88B-10PB



Wire End Covers

- 10 x Silver wire end covers

Pack of:	Part No:
10	CX88S-10PB



Rotor Bolts

- T25 Torx head
- Packs of 6

Colour:	Part No:
Black	CRB-6PB



Derailleur Hanger

- 1 x Derailleur hanger A

Pack of:	Part No:
1	CDH-1PB



V Brake Pipe & Boot

- V-Brake 90 degree bend with rubber boot

Pack of:	Part No:
1	CX23



V Brake Pipe & Boot

- V-Brake 135 degree bend with rubber boot

Pack of:	Part No:
1	CX24



Crank Bolts

- 2 x Allen key crank bolts

Pack of:	Part No:
2	CCB-2PB

SERVICE ■ WORKSHOP DISPENSER POTS

All the fittings below are supplied in individual dispenser pots. All dispenser pots are moulded from high quality polycarbonate and have Clarks branding applied

- Hydraulic disc brakes 4-17
- Mechanical disc brakes 18-23
- Disc pads 24-29
- Rotors 30-35
- Calliper brackets 36-39
- V-Brakes 40-43
- Brake pads & cartridges 44-49
- Cable kits & wires 50-57
- Cassettes 59
- Chains & accessories 60-61
- Chainrings 62-63
- Bottom brackets 64
- Gears 65
- Grips 66-75
- E-Bike 76-77
- Headsets 78-79
- Hydraulics 80-87
- Service - trays 88-89
- Service - Wire, cable & hose 90-91
- Service - Parts 92-94
- Bottle Cages 95



Brake/Gear Ferrule

- Available in pots of 50

Pot of:	Part No:
50	CF505DP



Brake Ferrule Steel

- Available in pots of 200

Pot of:	Part No:
200	CX15DP-200



Brake Ferrule Plastic

- Push fit
- Available in pots of 150

Pot of:	Part No:
150	Y2029DP-150



Brake 'O' Rings

- Available in pots of 200

Pot of:	Part No:
200	CX102DP-200



Gear Ferrule

- Available in pots of 50

Pot of:	Part No:
50	Z163DP



Gear Ferrule Steel

- Available in pots of 100

Pot of:	Part No:
100	CX18DP-100



Gear Ferrule Nylon

- Available in pots of 150

Pot of:	Part No:
150	CX20DP-150



Gear 'O' Rings

- Available in pots of 200

Pot of:	Part No:
200	CX103DP-200



Gear Ferrule Pressed Brass

- Brass pressed - 4.3mm
- Available in pots of 100

Pot of:	Part No:
100	CX16DP-A



Gear Ferrule Alloy

- Alloy - 4mm
- Available in pots of 200

Pot of:	Part No:
200	CX16DP-200



Brake Ferrule

- Available in pots of 100

Pot of:	Part No:
100	CP-B-01-DP



Gear Ferrule

- Available in pots of 100

Pot of:	Part No:
100	CP-G-01-DP



Wire End Cover Standard

- Available in pots of 500

Pot of:	Part No:
500	CX88DP



Wire End Cover Anodised

- Anodised
- Available in pots of 100

Pot of:	Colour	Part No:
100	Black	CX88DP-BLACK
100	Blue	CX88DP-BLUE
100	Light Green	CX88DP-LIGHTGREEN
100	Orange	CX88DP-ORANGE
100	Pink	CX88DP-PINK
100	Red	CX88DP-RED



SERVICE ■ BOTTLE CAGES

Replenishment helps to maintain performance and is essential for endurance activities. Clarks offers 2 basic cage designs, a full cage moulded from carbon or polycarbonate and a classic design supplied in plastic and anodised aluminium. All are high quality and great value cycle components.



BC-06

- Handle bar mount bottle cage
- Steel construction
- High quality anodised finish
- To fit bottle size 250-350ml

Steel
BC-06



BC-18

- High quality finish
- Manufactured from durable and light polycarbonate
- Great flexibility properties
- Total weight 31g
- Includes mount bolts

Black BC-18 | White BC-18W



BC-20

- High quality anodised coloured finish
- Durable and lightweight classic design
- Polycarbonate and aluminium construction
- Includes mount bolts

Black
BC-20



BC-20 (Coloured)

- High quality anodised coloured finish
- Durable and lightweight classic design
- Polycarbonate and aluminium construction
- Includes mount bolts

Blue BC-20-BLUE | Silver BC-20-SILVER
Red BC-20-RED



BC-23

- Polycarbonate
- Lightweight
- Side Loading
- Durable

Black
BC-23



BC-27

- High quality carbon weave
- Unmatched strength and superb looks
- Lightweight design and construction (26g)
- Unique design offers outstanding grip on bottles
- Includes mount bolts

Carbon
BC-27



BC-28

- Unmatched strength and superb looks
- Lightweight design and construction (24g)
- Universal bottle fit
- Includes mount bolts

Carbon
BC-28



BC-29

- Polycarbonate
- Lightweight with rubber grips
- Durable

White
BC-29

Hydraulic disc brakes
4-17

Mechanical disc brakes
18-23

Disc pads
24-29

Rotors
30-35

Calliper brackets
36-39

V-Brakes
40-43

Brake pads & cartridges
44-49

Cable kits & wires
50-57

Cassettes
59

Chains & accessories
60-61

Chainrings
62-63

Bottom brackets
64

Gears
65

Grips
66-75

E-Bike
76-77

Headsets
78-79

Hydraulics
80-87

Service - trays
88-89

Service - Wire, cable & hose
90-91

Service - Parts
92-94

Bottle Cages
95



UK Head Office & Distribution Centre

Sales, administration and finance. Design/
marketing and development department.
Service centre and customer support.
Warehouse.

Clarks Cycle Systems Ltd

Head Office,
6 Lakeside Court,
Maple Drive,
Hinckley, LE10 3BH
Tel: +44 (0)1455 254800
info@clarks.bike

Clarks China Office

Control of orders, suppliers and manufacturers.
Order processing.

Clarks Cycle System Co. Ltd Ningbo office

1103 Changqingting BLD,
NO.262, Lane 416 ZHAOHUI RD,
Yinzhou dist, Ningbo,
Zhejiang,
China.
Tel: + 86 (0) 574 87801640
info@clarkscyclesystems.com
